





SPM WALL PROTECTIONS AND HANDRAILS

gerflor.com



2016 COLLECTION

CONTENTS

▶ Responding to all your demands	5
▶ A range that respects environment	6
▶ Gerflor continues to innovate for you	7
▶ A practicable guide: solutions for all your needs	8/9
Selection guide: specific solutions per sector	10/21
▶ Specific solutions per sector	10/11
▶ Health - Hospital - Clinic	12/13
▶ Retirement home - Handicap	14/15
▶ Education	16/17
▶ Offices - Hotels - Catering - Housing	18/19
▶ Industry - Sport	20/21
Colour range	22/29
▶ A palette of 32 colours	22/23
▶ Decowood range	24/25
▶ Decotrend range	26
▶ Decosmic and Decochoc H2O panels	27
▶ Early childhood	28
▶ Safy range: individual protection	29
 Wall protection	30/53
Gerflor has developed a range of three products that have been tested: wall protection rails, protection plates and the decorative protection panels.	
 Corner protection	54/63
Our corner protectors are adhesived or with aluminium core and can be applied to all corners, whether right angled or not. All have the same properties: they resist impact and the effects of cleaning products.	
 Door protection	64/73
Gerflor has developed a range of plates and panels to suit all types of door. The panels come in a variety of original and decorative shapes and can be folded into L and U bends to protect edges or can be thermo-formed to protect frames.	
 Handrails	74/89
They are ergonomic, and also provide wall protection. SPM handrails are made from a combination of PVC and aluminium and cater for all your needs: they ensure mobility and provide security, and can be adapted to fit any building (curved surfaces, corners at variable angles, service ducts, staircases).	
Individual protection	90/91
Technical solutions	92/97
▶ Solutions for panels	92/93
▶ Fixing and finishing	93
▶ Solutions for handrails	94/95
▶ Tools	96/97
Colour availability summary chart	98/101
Documents and sample cards available	102/103
Alphabetic index	104



RESPONDING TO ALL YOUR DEMANDS

► PRIORITY TO HYGIENE



100% of bacteria are killed 30 minutes after decontamination

Hygiene standards

Gerflor commissioned an independent laboratory's hospital hygiene department, the Institute Pasteur of Lille, to perform a cleaning/decontamination study on its products. The tests conclude that SPM products, when cleaned in accordance with methods, detergents and disinfectants used within hospitals, can achieve effective decontamination levels and maybe also used in infectious risk critical areas. (Test reports No. C/0510506M and 1100908M)



Bacteriostatic PVC

The entire SPM range is specially designed to prevent build-up of dust and germs. The non-porous surface and rounded design of every product are the result of in-depth engineering studies. (Nosoco. tech laboratories, test reports n°10053101 and 10053102)

Chemical resistance

Gerflor uses independent testing laboratories to demonstrate how well its PVC extruded sections stand up to standard cleaning, disinfection and antiseptic products used in the healthcare and public buildings. (ANIOS Laboratory, test report n°17242.04/219, BIOQUELL® test report n° TD 041-003-14).

► PRIORITY TO PROTECTION

Impact resistance

To guarantee impact resistance, Gerflor tests its products in real operating conditions.

The weights to which they are subjected correspond to those of trolleys and the impact speeds reflect those of people on the move (320 kg at a 3 km/h speed).

Wrenching strength SPM

Several SPM products have been subjected to extremely

severe tests and have demonstrated their ability to resist tear-off. (CSTB Test n°BP13-6-4042-2)

Fire rating

Whatever its colour, the formula for SPM antibacterial PVC includes Bs2d0 fire rating according to EN 13501-1. To be eligible for this classification, our products (profiles and accessories) are submitted to full tests carried out by the licensed laboratories.

This body issues classification certificates based on the results obtained in its tests.





A RANGE THAT RESPECTS ENVIRONMENT

Gerflor manufactures its wall protection products and handrails from non-polluting and eco-friendly materials. All SPM products exceed the requirements of current regulations.

Exemplary composition

- **Non-polluting materials**
SPM PVC products contain no heavy metals such as lead, cadmium, arsenic, tin, etc and are PBT-free (Persistent Bioaccumulative Toxins) / BPA-free (Bisphenol A).

- **Calcium-zinc thermal stabilisation**

Gerflor has chosen to use calcium-zinc stabilisation, which is non-toxic and poses no environmental threat. Gerflor is therefore ahead of the game, emphasising yet again its commitment to sustainable development.



Health, Quality and Environmental guidelines: SPM products are suitable for use in building projects adopting High Quality Environment (HQE) standards.

European REACH Regulations

European Registration, Evaluation, Authorisation and Restriction of Chemicals (REACH) regulations are intended to improve protection standards for human health and the environment. They require all manufacturers to declare any chemical substances listed as hazardous that may be used in the composition of their products. None of the substances used to manufacture SPM products appears in the list drawn up under the REACH regulations.

Air quality

Our products are tested according to the norms serie ISO 16000-6.

They have a rate of less than 100 µg/m³ over 3 days, that is to say a tiny rate compared to the required threshold.

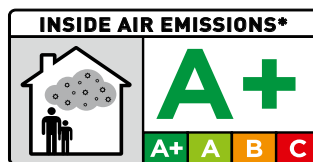

According to French regulations

* Information about the emission level of volatile substance in inside air, involving a toxic risk by inhalation, on a scale from A+ (very low emissions) to C (high emissions).

Our panels were rewarded with Greenguard and Greenguard Gold labels for their low emission ensuring



good air quality indoor.

Recycling

Our materials are mainly PVC and aluminium and thus 100% recyclable. To this end, all the offcuts from the manufacturing process are also recycled.

Reduced environmental impact during installation and in use

- **Adhesives**

We recommend the use of Gerflor adhesives when installing our products, either a water-based acrylic adhesive or a universal mastic glue on a MS polymer base. These adhesives use no solvents and thus present no threat to either the users' health or the environment.



- **Reduced levels of waste through custom-made lengths**

Gerflor offers a pre-cutting service (standard lengths from the catalogue or made to measure) that eliminates wasteful offcuts and recycles the offcuts from the sizes cut to length.

- **Cleaning and maintenance**

The products are easy to clean and reduce the consumption of both water and cleaning products.

- **Durability**

Gerflor solutions extend infrastructural life spans and also extend considerably the intervals between wall repair and renovation work.



GERFLOR CONTINUES TO INNOVATE FOR YOU

IN A NUMBER OF OTHER DOMAINS.

Gerflor conforms to environmental regulations by offering products with no risk to human health and the environment, whilst also coming up with new ideas in several other fields.

An exclusive new colour chart with 51 on-trend colours and decors created with the help of our partner architects and colourists and allowing us to offer an even wider choice:

- **Magnolia pink**, voted colour of the year
- 3 new metallic **Decosmic** colours, perfect as part of a contemporary decor scheme
- 2 new **Decowood** finishes for a designer feel with warmth
- 2 new **concrete designs** in the **Decotrend** range, essential decor looks!



The new Fin'color profile provides an aesthetic finish and a perfect joint between panels or between panel and floor skirting. Available in all colours in the range, it brings a subtle decorative touch for a harmonious whole.

The new LINEA range

with its sleek, contemporary lines offers performance, ergonomics and a uniform design throughout a building, regardless of the impact resistance required. The all-round matching solution for effective wall protection consisting of Linea'Punch protection rail, Linea'Flex corner protection and Linea'Touch handrails.



The SAFY range

is all about people protection. The Safycorner cushioning corner protector and Safydoor door finger protection system improve safety levels in premises and help reduce accidents.



SPM in BIM objects

Always attentive to the needs of its customers and partners, Gerflor offers the opportunity to download BIM objects for Revit and ArchiCAD covering its entire range.

Decoprint printed panels created by Gerflor protect and personalize your walls and doors using digital printing (reproduction of photos, drawings, messages, logos, etc.). In 1 mm or 2 mm versions, these panels are the ideal decoration or protection solution adding an aura of elegance and originality to your establishment.



The new DECOCHOC H₂O panels - an innovative solution for protecting walls and doors in wet rooms. The formulation and grained surface are perfectly suited to wet areas and provide total and long-lasting watertightness validated by ATEX (Technical Evaluation of Experimentation) certification issued by the CSTB.

The bactericidal joints used with our handrails help in the fight against the transmission of hand-borne contamination, which is responsible for the great majority of hospital acquired infections. (Nosoco. tech laboratories, test report n°08112803)

Most of our profile strips come with **a peel-off protective film** to protect them from any marks whilst work is in progress. When left on until the time of acceptance, this film prevents the need for complete cleaning of our products.

Accessibility: we have developed numerous solutions to meet accessibility requirements:

- **Adjustable and variable 3D angle Rapid'Angle** to fit in all staircases layouts and to all angles from 80° to 180°.
- **The option of high visual contrast** using a well thought-out range of colours that provide wall protection in neutral and natural shades against which our handrails, in their bright, vivid colours, stand out and are immediately visible to users with impaired vision.
- **Powerful visual identifiers** based on outline shapes and inlays that customize doors and walls and make it easier to recognise places and find one's way, especially for those with impaired cognition.
- **Tactile identifiers** are available for Escort handrails using their unique design of finishing strip that can be customized on request.
- **A double bracket** for the simple installation of Escort handrails at two heights, one standard, the other for children and those using wheelchairs.

A PRACTICAL GUIDE

SOLUTIONS FOR ALL YOUR NEEDS

The solutions

Gerflor has worked closely with its customers, in order to understand their specific needs. This partnership has led to the development of a complete range of solutions that cater for your every need. Whether you need to protect walls from impact and wear, shield areas that are prone to damage, or install handrails that provide both protection and aid mobility – whatever you require, Gerflor has the total solution for you.



Assistance: for any advice please contact us

Specification

It provides you with the necessary information about specifications, such as technical information, a complete description and fitting instructions.

Applications

By detailing the practical applications of each product we can help you to make the right choice for your particular needs.

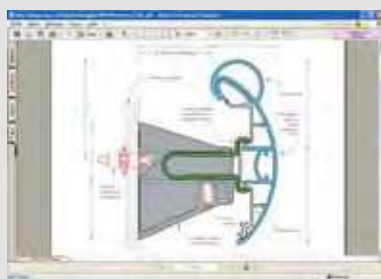
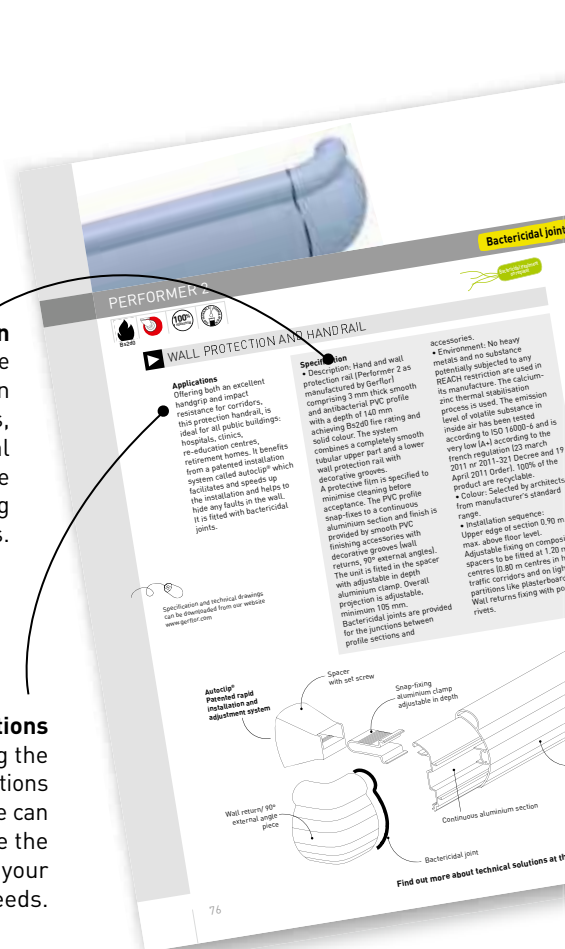

gerflor.com

PRACTICAL INTERNET

All our technical information-specifications, technical drawings (scale 1)- and installation advices can be downloaded from our website.

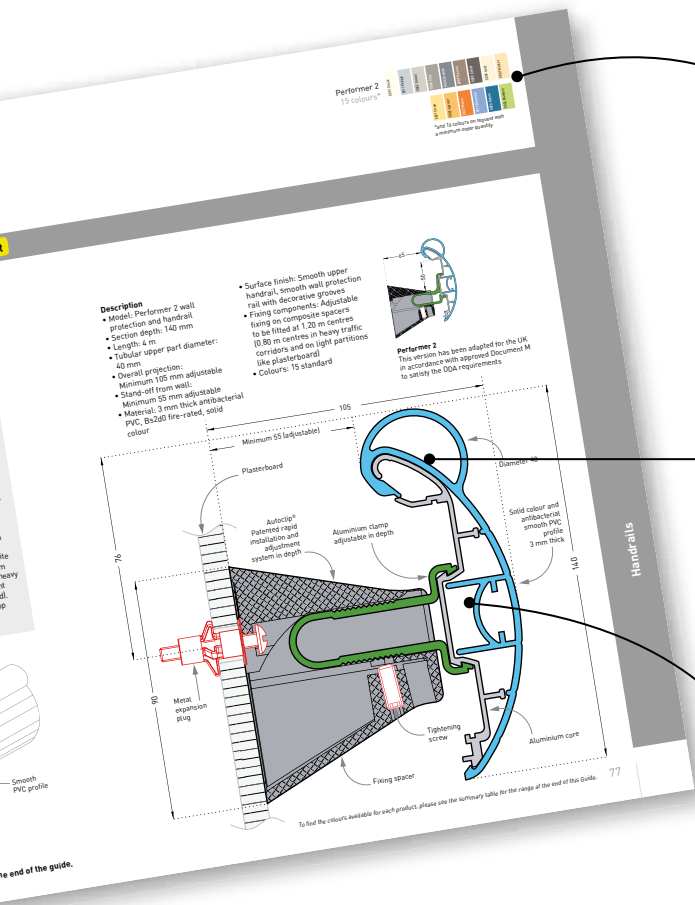

Range of colours
See all the colours available for the product at a glance

Technical drawings
This enables you to see everything clearly (scale 1): the strong points and particulars of each of our products, including the mounting systems.

Installation procedures
To help with the installation of our products, the installation procedures guide is available upon request.



A single colour code
The same colour code is used throughout: blue for the profiles, orange for contrast strips and finishing, grey for the aluminium mountings, green for interlocking parts, and red for screws and glues.

Product overview

This provides you with all the information concerning a particular product.

CLASSIFICATION FOR PROTECTION REQUIREMENTS

- Solutions for "protection" vary according to which areas of a building are subjected to impact, or intensive use by people and mobile equipment. We have established a classification system for the various applications and have given them a colour code that can be used as a guide throughout our catalogue.



A COLOUR CODE FOR EVERY APPLICATION

Red > For heavy traffic areas

Intensively used areas that are subjected to hard impact



Green > For moderate traffic areas

Standard intensity areas that are repeatedly subjected to impact



Blue > For light traffic areas

Low intensity areas that are subjected to light impact and localised wear

SPECIFIC SOLUTIONS PER SECTOR



Health Hospitals, clinics

Priority for Hygiene

In operating theatres, clean-rooms, laboratories... hygiene has to be the number one priority more than anywhere else. We develop antibacterial and bacteriostatic PVC that do not collect germs and are resistant to disinfectants.

Impact resistance

Each corridor, each passage way has its own traffic. Our wall protection systems and handrails fit in with different impact intensities or wear, from occasional passage to heavy traffic.

Easy maintenance

Non-porous surfaces and curved shapes have been developed with hygienists to prevent germ incrustation. Our PVC is resistant to solvents, diluted acids and industrial detergents.

Simplified installation

Our products are designed to be easily installed and to limit noise and chemical pollution during the installation: easy and quick fitting together, odourless glues.

Retirement homes Handicap

Comfort

As the bedroom becomes the patient's main living room, the risks related to moving furniture is increased (beds, wheelchairs, service trolleys, chairs...). SPM wall protections protect against wear, whilst providing well-being and comfort.

Ergonomics

Our handrails are especially designed for a perfect handgrip and provide safe support for users.

Living environment

SPM wall protections and handrails enhance interiors whilst offering a warmer living environment, and contribute to well-being of the elderly. Pastel or bright, colours will fit perfectly into the existing décor and facilitate visual guidance.



Education

Heavy traffic

In public areas, the heavy and repeated flow of pupils or equipment creates premature and intensive wear and tear. So that these living and working areas are friendly and resistant, Gerflor has designed ranges of wall protections to meet these requirements.

Maintenance

Gerflor protection systems reduce wear and tear as well as impacts on walls and extend the lifetime of buildings. Easy to clean and maintain, they contribute towards reducing maintenance costs.

Aesthetic

Gerflor solutions help you to create and preserve pleasant settings, colourful and fun décors which encourages the well-being of toddlers. They enhance your premises whilst maintaining them in good condition.



Industry

Controlled environment

In the pharmaceutical sector, especially in clean rooms, the control of bacteriological contamination is essential. Gerflor develops solutions that meet these requirements.

High impact resistance

High-load trolleys pass through corridors, technical areas, logistical premises. Gerflor wall protections provide unmatched impact resistance and protect premises for a long time.

Quick installation

On-going activity must not be interrupted. Gerflor wall solutions are easy and quick to install, ensuring very short period of downtime of the premises.

Hotels / Catering

Enhance your image

In an environment constantly and heavily frequented by people, a refined and welcoming decor adds to the appeal of your establishment. Gerflor's decorative and easy-to-maintain solutions preserve walls and doors against wear and tear due to luggage, cleaning trolleys, chairs and tables, traces of soiling around handles, etc. They can provide a decorative touch or blend discreetly into the background.



Housing

Protecting infrastructure

Given high foot traffic and potential soiling or damage, it is essential to protect building infrastructure. Gerflor solutions preserve premises durably against impacts on walls, doors and corners and facilitate maintenance and cleaning. They contribute to a pleasant and safe living environment and meet relevant health and safety requirements.



Sport

Large width protection

In gymnasiums, impacts (of balls, sticks, studs...) can appear anywhere. So it is important to protect the more exposed areas: lower parts of walls, doors, angles, in order to keep the premises in a good state. In other areas where physical activities are practiced (dancing, fitness and martial arts), the wall protection protects from wear and tear and makes maintenance easier.



Damp areas

The cloakrooms and notably the shower areas have to be protected against the damaging effects of dampness: corrosion, moulds. Gerflor solutions contribute to making these areas more water-proof : welded panels and doors protected with bends and cut-outs.

All SPM products have been designed and tested to be installed indoors.

HERE NOTHING IS LEFT TO CHANGE

HEALTH - HOSPITAL - CLINIC

	WALL PROTECTION																	
	Linea Punch 180	Impact 200	Impact 120	Impact 60	Contact 350	Contact 200	Decochoc (edge to edge, silicone joint)	Decochoc (hot welded)	Decosmic 	Decowood panel	Decotrend panel	Decoclean	Decochoc H ₂ O 	Bedkit	Decofresc Decorative frescoes	Decoprint	Plac'Inox	
ACCOMMODATION: Corridors																		
Patient rooms, Common areas	*	*				*	*		*	*	*				*	*		
Hospital room (including bathrooms) Patient bedroom	*	*			*		*		*	*	*			*				
Other																		
Examination room Patient Preparation room, nursery, staff room	*	*					*		*									
Patients' lounge, relaxation room	*	*				*	*		*	*						*		
Services area (laundry and equipment store)	*	*					*		*									
TECHNICAL MEDICAL PLATFORM: Emergencies																		
Corridors	*	*					*		*									
Reception, waiting room	*	*				*	*		*	*	*				*	*		
Examination and treatment room	*	*			*		*	*	*	*	*				*	*		
Surgery or obstetric examination unit																		
Corridors	*	*	*				*		*							*		
Operating theatre								*				*						
Recovery room								*				*						
Laboratories-Sterilisation																		
Laboratories	*	*			*		*		*			*						
Central sterilisation and conditioning	*	*			*		*					*						
DAY-TIME HOSPITAL, CONSULTATION, FUNCTIONAL REHABILITATION, CENTRAL PHARMACY, MORGUE																		
Waiting room and corridors			*							*	*					*		
Consultation and external examination room						*	*		*							*		
Laundry and clean equipment store, pharmacy store	*	*					*		*									
Physiotherapy and occupational therapy room							*		*							*		
ADMINISTRATION, GENERAL SERVICES AND FACILITIES																		
Staff restaurant, cafeteria					*		*		*	*	*					*		
Laundry, laundry store	*	*					*		*									
Toilets, cloakrooms							*		*				*					
Central laundry, central kitchens and annexes	*	*	*				*		*				*					
Reception and corridors																		
Hall and elevator area																*		
Stairs																		





CORNER PROTECTORS								DOOR PROTECTION								HANDRAILS										
Capcorn	Cornea	Corneaflex	Linea Flex	Protecta 2, Profila	Decosmic corner L-bent (in line with walls)	Decowood / Decotrend corner L-bent (in line with walls)	Profil'inox	Complete doors (2 sides)	1/2 height door	Foot-height door	1/2 height decorative door	Handplates	1/2 height door Inlaid signage	Bendings Edges and frames	Plac'inox	Performer 2	Starline - PVC sheathed	Starline - Anodised	Starline Decowood / Decotrend	Linea Touch+ - PVC sheathed	Linea Touch - PVC sheathed	Linea Touch - Decowood	Linea Touch - Anodised	Escort - PVC sheathed	Escort - Decowood	Escort - Anodised
*	*	*		*					*		*		*		*	*			*	*			*			
			*	*	*	*		*					*													
*			*	*	*	*		*	*		*		*	*												
*	*	*		*	*	*		*	*		*		*	*					*							
	*	*						*	*				*	*	*											
	*	*						*	*				*	*												
	*	*		*	*	*		*	*				*	*						*	*			*	*	*
	*	*		*	*	*		*	*				*	*						*	*			*	*	*
	*	*		*	*	*		*	*				*	*						*	*			*	*	*
	*	*		*	*	*		*	*				*	*						*	*			*	*	*
	*	*		*	*	*		*	*				*	*						*	*			*	*	*
	*	*		*	*	*		*	*				*	*						*	*			*	*	*

* Gerflor recommendation ■ Other possible solutions

CONTRIBUTING TO RESIDENT WELL-BEING

RETIREMENT HOME - HANDICAP

	WALL PROTECTION															
	Linea Punch 180	Impact 200	Impact 120	Impact 60	Contact 350	Contact 200	Decochoc (edge to edge, silicone joint)	Decosmic 	Decowood panel	Decotrend panel	Decoclean	Decochoc H ₂ O 	Bedkit	Decofresc Decorative frescoes	Decoprint	Plac'Inox
CORRIDORS																
Moderate traffic corridors	*	*			*	*	*	*	*	*					*	
Elevator	*	*	*				*	*							*	
Elevator landing	*	*	*				*	*							*	
ACCOMMODATION AND ROOM SERVICE																
Patient room	*	*			*	*	*	*	*	*			*		*	
Wash room							*	*				*				
Sanitary arrangements							*	*				*				
PUBLIC PREMISES																
Residents' dining room, entertainment rooms	*	*	*		*		*	*	*	*				*	*	
Relaxation, leisure room					*		*	*	*	*					*	
CONSULTATION AND TREATMENT UNITS																
Nursing station			*			*	*	*							*	
Consultation room						*	*	*							*	
Physiotherapy, occupational therapy and functional rehabilitation room							*	*							*	
TECHNICAL PREMISES																
Product and equipment storage (treatments, nappies)	*	*					*									
Laundry room, laundry storage	*	*					*									
Central kitchen and annexes	*	*	*				*					*				





CORNER PROTECTORS							DOOR PROTECTION							HANDRAILS											
Capcorn	Cornea	Corneaflex	Linea'Flex	Protecta 2, Profila	Decosmic corner L-bent (in line with walls)	Decowood / Decotrend corner L-bent (in line with walls)	Profil'inox	1/2 height door	Foot-height door	1/2 height decorative door	Handplates	1/2 height door Inlaid signage	Bendings Edges and frames	Plac'inox	Performer 2	Starline - PVC sheathed	Starline - Anodised	Starline Decowood / Decotrend	Linea'Touch+ - PVC sheathed	Linea'Touch - PVC sheathed	Linea'Touch - Decowood	Linea'Touch - Anodised	Escort - PVC sheathed	Escort - Decowood	Escort - Anodised
*	*	*	*	*				*		*		*	*		*			*	*	*			*		
					*																				
*	*	*			*										*				*	*			*	*	
*			*	*	*	*				*		*		*											
*			*	*	*	*				*		*		*											
			*	*					*		*														
			*	*				*	*		*									*	*		*	*	
	*	*						*			*	*	*												
	*	*						*			*	*	*												
	*	*						*			*	*	*												

* Gerflor recommendation ■ Other possible solutions

A WELCOMING ENVIRONMENT FOR PUPILS

EDUCATION

	WALL PROTECTION														Capcorn	Cornea	Corneaflex
	Linea Punch 180	Impact 200	Impact 120	Impact 60	Contact 350	Contact 200	Decochoc	Decosmic 	Decowood panel	Decotrend panel	Decochoc H ₂ O 	Decofresc Decorative frescoes	Decoprint	Decokid Educational panels			
KINDERGARTENS AND NURSERIES																	
Corridors						*	*	*				*	*	*			
Entry hall, reception and relaxation areas						*	*	*				*	*	*			
Classrooms						*	*	*				*	*				
Stairs							*	*				*					
Play and exercise room					*		*	*				*	*				
PRIMARY SCHOOLS																	
Corridors						*	*	*				*	*	*			
Entry hall, reception and relaxation areas						*	*	*	*	*		*	*	*			
Classrooms						*	*	*				*	*				
Stairs							*	*				*					
Play and exercise room							*	*				*	*				
ELEMENTARY AND MIDDLE SCHOOLS																	
Corridors						*	*	*	*				*				
Entry hall, reception and relaxation areas							*	*	*	*	*		*				
Stairs								*	*				*				
Classrooms						*	*	*	*				*				
Physical education areas								*	*				*				
Science and IT rooms, laboratories			*		*	*	*	*					*				
HIGHER EDUCATION																	
Corridors						*	*	*	*				*				
Stairs								*	*				*				
Teaching rooms						*	*	*	*	*	*		*				
IT rooms																	
Laboratories						*	*	*	*							*	
Accommodation (including student residences)							*	*	*				*				
ANNEX TEACHING AREAS																	
Cafeterias, dining room, multi-purpose room						*	*	*	*	*	*		*	*		*	
Sanitary arrangements								*			*						
Kitchens and annexes	*	*	*				*	*			*					*	*
Corridors in a technical premises area	*	*	*				*	*								*	
Nursing station, medical area						*	*	*	*	*							
Archives, filing rooms	*	*	*		*	*											





PROTECTING AND ENHANCING INFRASTRUCTURE

OFFICES - HOTELS - CATERING - HOUSING

	WALL PROTECTION																
	Linea Punch 180	Impact 200	Impact 120	Impact 60	Contact 350	Contact 200	Decochoc	Decosmic NEW	Decowood panel	Decotrend panel	Decochoc H2O NEW	Bedkit	Decofresc Decorative frescoes	Decoprint		Decokid Educational panels	Plac'Inox
BUSINESS PREMISES																	
Offices							*	*	*	*					*		
Meeting rooms and waiting rooms							*	*	*	*							
ANNEXES AND TECHNICAL PREMISES																	
Archives, filing rooms					*	*											*
Sanitary arrangements										*							*
Company restaurant, cafeteria							*	*	*	*							
Central kitchen and annexes	*	*	*				*	*		*							*
Corridors in a technical premises area	*	*			*	*	*										*
HOTEL SECTOR: Accommodation																	
Corridors in public areas					*		*	*	*	*							
Corridors in technical areas	*	*		*	*		*	*									*
Entry hall, reception							*	*	*	*							
Stairs							*	*									
Waiting and meeting rooms							*	*	*	*							
Restaurant							*	*	*	*							
Bedrooms							*	*	*	*							
Sanitary arrangements						*				*							
Central kitchen and annexes	*	*	*				*			*							*
HOUSING																	
Entry hall					*	*	*	*	*	*				*			
Corridors					*	*	*	*	*	*				*			
Stairs and stairwells					*	*	*	*	*	*				*			
Lifts							*	*	*	*				*			
Trash premises							*										
Bathrooms and sanitary arrangements											*						
Kitchens											*						

EFFECTIVENESS AND COMPLIANCE WITH STANDARDS

INDUSTRY - SPORT

	WALL PROTECTION																
	Linea'Punch 180	Impact 200	Impact 120	Impact 60	Contact 350	Contact 200	Decochoc	Decosmic 	Decowood panel	Decotrend panel	Decoclean	Decochoc H2O 	Decofresc Decorative frescoes	Decoprint	Decokid Educational panels	Plac'Inox	Capcorn
LIFE SCIENCES																	
Laboratory, clean rooms, airlocks							*	*			*			*			
Storage, laundry	*	*					*	*				*					
HEAVY INDUSTRIAL TRAFFIC (for areas with non-motorised trolleys)																	
Corridors	*	*			*	*	*	*									
Conditioning							*	*									
Production							*	*									
Storage	*	*			*	*	*	*									
	WALL PROTECTION																
	Linea'Punch 180	Impact 200	Impact 120	Impact 60	Contact 350	Contact 200	Decochoc	Decosmic 	Decowood panel	Decotrend panel	Decoclean	Decochoc H2O 	Decofresc Decorative frescoes	Decoprint	Decokid Educational panels	Plac'Inox	Capcorn
HEAVY TRAFFIC AREAS																	
Circulations					*	*	*	*	*	*				*			*
Stairs							*	*						*			
SPORTS AREAS																	
Gymnasium							*	*					*	*	*		*
Fitness and body building room							*	*	*	*			*	*	*		*
PUBLIC AREAS																	
Cafeteria, bar						*	*	*	*	*				*			
ADMINISTRATION / ADMINISTRATIVE OFFICES																	
Cloakrooms							*	*	*	*			*	*	*		
WET ROOMS																	
Showers / Sanitary arrangements					*							*					



CORNER PROTECTORS						DOOR PROTECTION						HANDRAILS													
Cornea	Corneaflex	Linea Flex	Protecta 2, Profila	Decosmic corner L-bent (in line with walls)	Decotrend corner L-bent (in line with walls)	Profil'inox	Complete doors (2 sides)	1/2 height door	Foot-height door	1/2 height decorative door	Handplates	1/2 height door Inlaid signage	Bendings Edges and frames	Plac'inox	Performer 2	Starline - PVC sheathed	Starline - Anodised	Starline Decowood / Decotrend	Linea Touch+ - PVC sheathed	Linea Touch - PVC sheathed	Linea Touch - Decowood	Linea Touch - Anodised	Escort - PVC sheathed	Escort - Decowood	Escort - Anodised
*	*			*			*	*				*	*												
*	*			*		*	*	*			*	*	*	*											
*	*			*		*	*	*			*	*	*	*											
*	*			*		*	*	*			*	*	*	*											

CORNER PROTECTORS						DOOR PROTECTION						HANDRAILS													
Cornea	Corneaflex	Linea Flex	Protecta 2, Profila	Decosmic corner L-bent (in line with walls)	Decotrend corner L-bent (in line with walls)	Profil'inox	Complete doors (2 sides)	1/2 height door	Foot-height door	1/2 height decorative door	Handplates	1/2 height door Inlaid signage	Bendings Edges and frames	Plac'inox	Performer 2	Starline - PVC sheathed	Starline - Anodised	Starline Decowood / Decotrend	Linea Touch+ - PVC sheathed	Linea Touch - PVC sheathed	Linea Touch - Decowood	Linea Touch - Anodised	Escort - PVC sheathed	Escort - Decowood	Escort - Anodised
				*					*	*	*	*								*			*		
		*	*	*	*			*	*	*	*	*													
		*	*	*	*			*	*	*	*														
		*	*	*	*			*	*	*	*	*	*												
		*	*					*	*	*	*	*	*												

* Gerflor recommendation ■ Other possible solutions

A PALETTE OF 32 COLOURS

Let wall protection play a dynamic role in decoration

NATURAL



0001 Chalk LRV 85.8

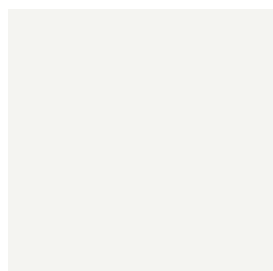

0031 Alum LRV 72.6

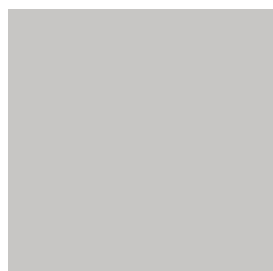

0032 Flint LRV 43.0



0033 Slate LRV 6.5

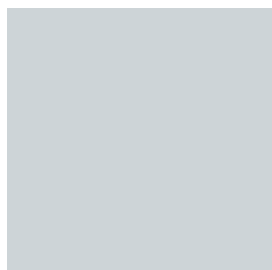

0011 Pebble LRV 56.2

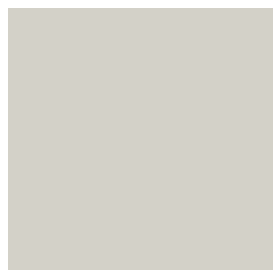

0002 Gravel LRV 53.4



0003 Clay LRV 33.3



0004 Granite LRV 25.1



0014 Cinnamon LRV 40.1



0009 Sienna LRV 27.2

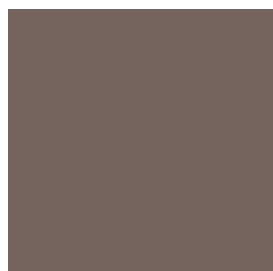

0010 Bark LRV 16.3



0005 Schist LRV 16.3



0006 Ivory LRV 82.5



0007 Wicker LRV 70.9



0008 Sand LRV 52.5



0013 Greige LRV 40.7

Gerflor offers a range of colours designed with the help of architects, interior designers, users, etc. The colour chart extended to 32 colours, from the most sober to the most daring, gives a new identity to interior designs whilst blending perfectly with other decorative elements such as floors, walls, doors, etc.

This palette brings together neutral, sober, mineral shades that blend naturally with architectural design and vivid, refreshing, full-bodied and youthful colours. Tinted greys now appear in the palette to provide subtle, muted ambiances.

Let SPM wall protection play a dynamic role in the aesthetic appearance of your facility.

COLOUR



0021 Straw LRV 65.5



0022 Apricot LRV 56.7



0027 Melon LRV 35.9



0028 Poppy LRV 16.7



0034 Magnolia LRV 53.6

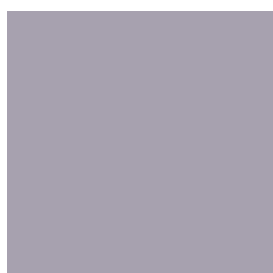

0015 Lavender grey LRV 34.7



0030 Iris LRV 17.4



0029 Garnet LRV 11.4

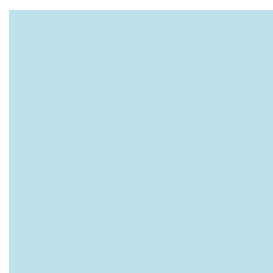

0016 Glacier LRV 64.2



0018 Azure LRV 44.5



0017 Bluebell LRV 36.9



0020 Denim LRV 16.8



0024 Bamboo LRV 52.4



0023 Meadow LRV 53.6



0025 Emerald LRV 29.3



0019 Ultramarine LRV 28.4

Colours are not contractually binding.

Please note

LRV (Light Reflectance Value) measures based on Decochoc panel.

In order to speed up delivery of your orders, we have adapted our colour range in line with our products:

- Most of our products are available in all 32 colours in the range.
- Certain products, however, are only immediately available in 15 colours, with the other 16 colours available on request*.

- The remaining products come in 5 colours with the other 26 colours available on request*.

Each product display page shows the number of colours available and there is a summary table p.98 to 101 of the guide for all the products.

* with a minimum order quantity

DECOWOOD RANGE

7 WOOD EFFECT FINISHES

A coordinated range

Gerflor offers a full range of decorative wood finishes for use in those establishments that wish to combine wall protection and handrails with the warmth of wood. This range consists of products matched to various requirements, providing safety for all with the Escort, Linea and Starline handrails, wall and door protection with Decowood protection panel and corner protection with the bent Decowood panel.

A wide choice of wood finishes

The range has been expanded with two new wood finishes, chosen to suit all interiors. To the five existing lines Maple, Beech, Light Oak, Wenge and Stripped Pine, we have added Brown Pine and Smoky Cedar.

Adhesive corner protector in bent **Decowood**



Decowood Linea'Touch Handrail



0060 Maple



Decowood Escort Handrail



0060 Maple



Decowood Starline Handrail



Band: 0060 Maple

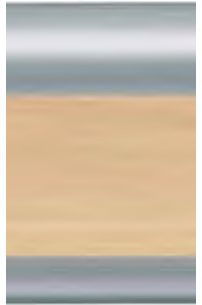

Decowood protection panels



0060 Maple



0061 Beech



0062 Light Oak



0067 Wenge



0065 Stripped Pine

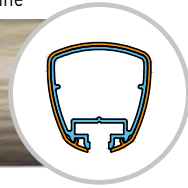

0061 Beech



0062 Light Oak



0067 Wenge



0065 Stripped Pine

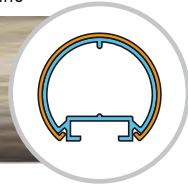

NEW

0061 Beech



0062 Light Oak



0067 Wenge

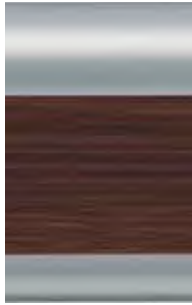

0065 Stripped Pine



0069 Brown Cedar

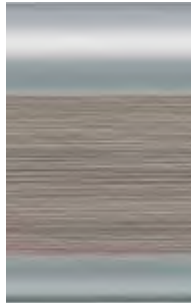

0068 Smoky Cedar



0061 Beech



0062 Light Oak



0067 Wenge

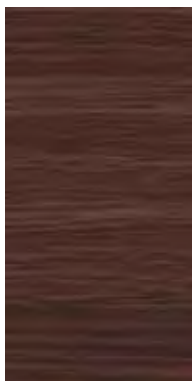

0065 Stripped Pine



0069 Brown Cedar



0068 Smoky Cedar



LRV 40.3

LRV 35.4

LRV 6.6

LRV 37.0

LRV 10.5

LRV 18.4

Colours are not contractually binding.

DECOTREND RANGE

Decotrend Starline Handrail

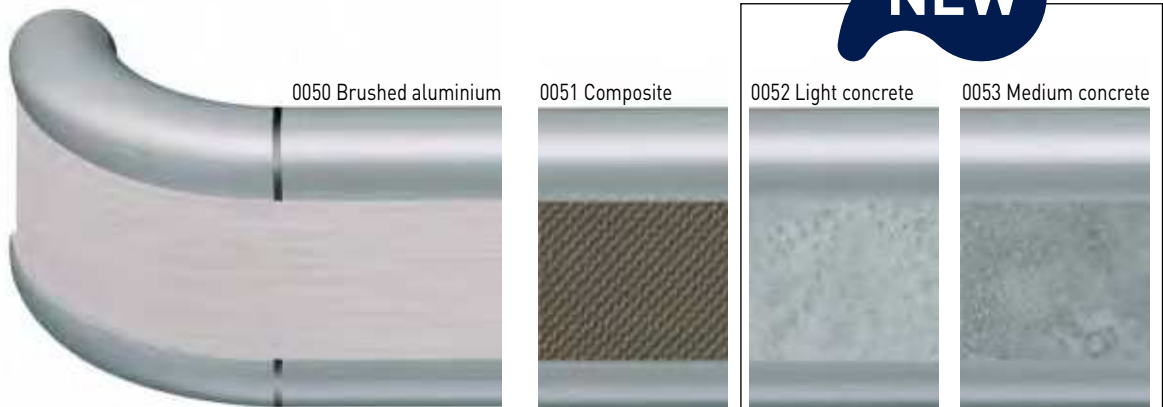

Decotrend decorative protection panel



Adhesive corner protector in bent Decotrend

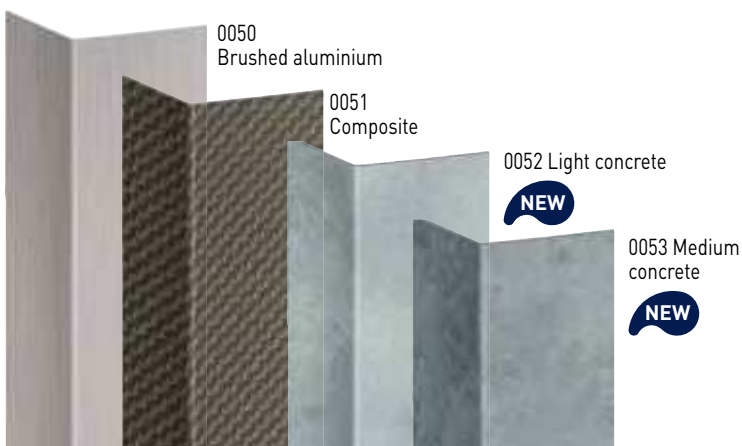

To combine decoration and protection, Gerflor has designed some new finishes to inspire the creation of individual, distinctive and damage resistant spaces. The overall approach is modern and urban.

These finishes lend themselves to some astonishing visual effects:

- a shaped perspective view with "Composite"
- a striking appearance of "Brushed Aluminium"
- a resolutely material effect with "Light concrete" and "Medium concrete".

DECOSMIC AND DECOCHOC H₂O PANELSDECOSMIC **NEW**

Decosmic protection and covering panel - Metallic look

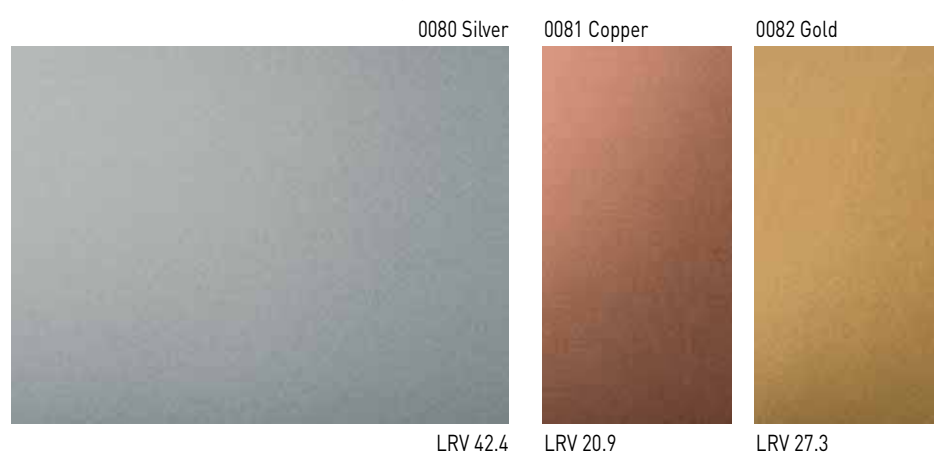

The metallic colours of DECOSMIC panels, combining protection with contemporary design, embellish your spaces in a stylishly modern way and create a unique look for your establishment.

- Silver brings elegance, modernity and simplicity
- Copper, very on-trend, is perfect for creating a contemporary decor look
- Gold lights up your spaces, enhancing them and creating warmth

DECOCHOC H₂O **NEW**

Decochoc H₂O protection and covering panel in wet area

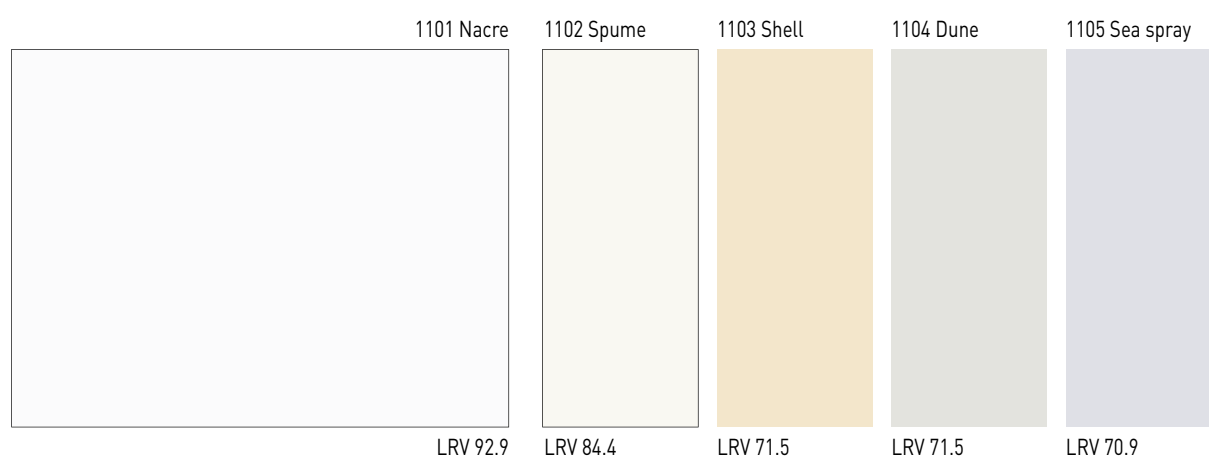

Gerflor's DECOCHOC H₂O panels protect walls and doors in wet rooms.

The matt surface of the panels and the 5 selected neutral shades of white, beige and grey will add understated style to your spaces while also offering scratch resistance and total watertightness.

EARLY CHILDHOOD

Decofresc decorative protection frescoes

Savannah theme



Picture 0



Picture 1



Picture 2



Picture 3

Maritime theme



Picture 0



Picture 1



Picture 2



Picture 3

Mountain theme



Picture 0



Picture 1



Picture 2



Picture 3

Decokid educational panels



1. I cross the road at a pedestrian crossing.



2. Early to bed, early to rise.



3. 30 mph, that's the urban speed limit.



4. I always say, 'Hello'.



5. I always put my rubbish in the bins provided.



6. I always wash my hands before eating.



7. I always wear my seat belt in the car.



8. I take breaks from my video games.



9. I always wash my hands after using the toilets.



10. No pushing.



11. I never leave the tap running.



SAFYCORNER

Safycorner 90° adhesive cushioning corner protector

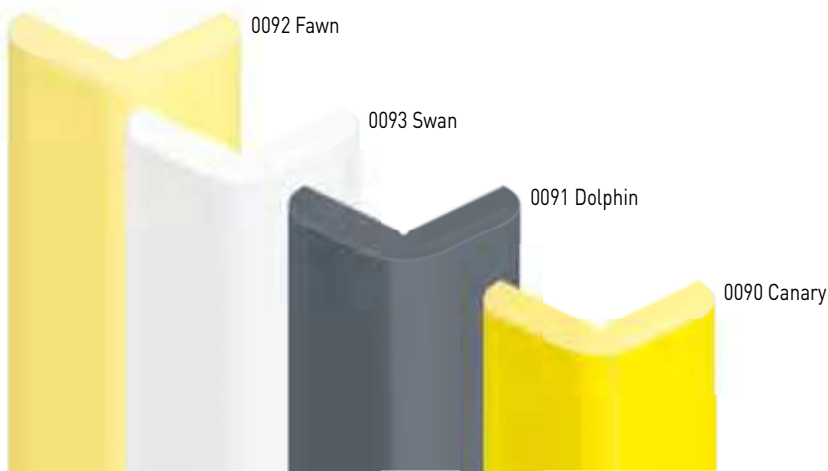

SAFYDOOR

Safydoor door finger protection

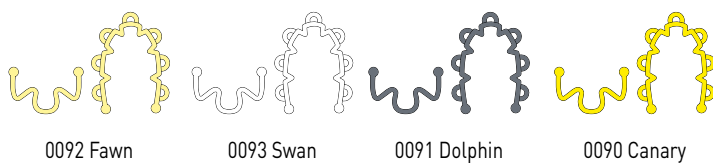

The SAFY range is all about individual protection and Gerflor has selected colours with two potential requirements in mind:

- The wish to make premises safe in a discreet way with the neutral colours Swan, Fawn and Dolphin
- The need to provide warning signals while also enlivening spaces with bright Canary.



SPM WALL PROTECTION



Clinique Sarrus Teinturiers - Coloriste N. Bernat



All public buildings have similar difficulties: premature deterioration together with wear and tear of their premises. Corridor walls, corners and doors are constantly knocked by trolleys and are damaged by continuous pedestrian traffic. In addition to preserving the interior, asepsis is absolutely imperative in operating theatres and clean rooms. Gerflor has developed three ranges of products that have been tested in order to offer you the most appropriate solutions – wall protection rails, protection plates, and the decorative protection panels. All are resistant to impact, germs and cleaning products. They are made from solid-colour and antibacterial PVC therefore the colour will not alter with cleaning or time.

	Code	Description	Material	Colour range
LINEA'PUNCH		Wall protection rail	PVC	31 colours
IMPACT		Wall protection rails	PVC	31 colours
CONTACT		Protection plates	PVC	31 colours
DECOCHOC		Protection and covering panel	PVC	32 colours
DECOSMIC		Protection and covering panel Metallic look	PVC	3 colours
DECOWOOD		Decorative protection panel	PVC	7 wood effect colours
DECOTREND		Decorative protection panel	PVC	4 trend decors
DECOCLEAN		Smooth protection panel	PVC	5 colours
DECOCHOC H₂O		Protection and covering panel in wet area	PVC	5 colours
FIN'ALU		Finishing and jointing profiles	Aluminium	Satin silver anodised
FIN'COLOR		Finishing and/or jointing profile	PVC	32 colours
DECOFRESC		Protection and decorative frescoes	PVC	3 themes with 4 pictures each 1 theme with 2 patterns
DECOPRINT		Customized protection panel	PVC	-
DECOCARE		Hand-hygiene panel	PVC	2 models
DECOKID		Educational panel	PVC	11 models
BEDKIT		Bed head protection	PVC + aluminium	31 colours
PLAC'INOX		Protection plate	Stainless steel	Brushed



LINEA'PUNCH p.32-33

Wall protection rail
height 180 mm



IMPACT 200 p.34-35

Wall protection rail
height 200 mm



IMPACT 120 p.34-35

Wall protection rail,
height 120 mm



IMPACT 60 p.34-35

Wall protection rail,
height 60 mm



CONTACT 350 p.36-37

Protection plate,
height 350 mm

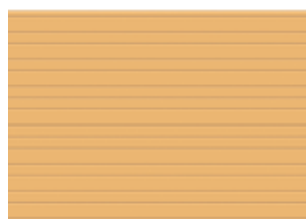

CONTACT 200 p.36-37

Protection plate,
height 200 mm

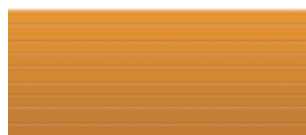

DECOCHOC p.38

Protection and
covering panel



DECOSMIC p.39

Protection and
covering panel
metallic look

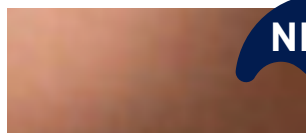

NEW

DECOWOOD p.40

Decorative
protection panel



DECOTREND p.41

Decorative
protection panel



DECOCLEAN p.42

Smooth
protection panel



DECOCHOC H2O p.43

Protection and
covering panel
in wet area



NEW

FIN'ALU p.44

Finishing and
jointing profiles



FIN'COLOR p.45

Finishing and/or
jointing profile



NEW

DECOFRESC p.46-47

Protection and
decorative frescoes



DECOPRINT p.48-49

Customized protection
or decoration panel



DECOCARE p.50

Hand hygiene
panel

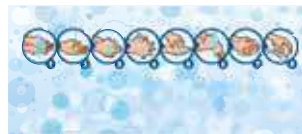

DECOKID p.51

Educational panel



BEDKIT p.52

Vertical bed
head protection



PLAC'INOX p.53

Brushed stainless steel
protection plate



LINEA'PUNCH



▶ 180 MM HEIGHT WALL PROTECTION RAIL

Applications

The Linea'Punch protection rail is the perfect alliance between impact resistance and design.

Its uncluttered line helps it merge with the decor, and matches perfectly the Linea'Touch handrail for an aesthetic and high-performance solution throughout the building.

Its narrow bevelled end pieces minimise projection and reduce the distance to door frames, and the wall-hugging profile makes for easy cleaning and maximum hygiene. It is easy and quick to install, thanks to its double clipping.

It provides effective and discreet protection for walls exposed to heavy trolley traffic in corridors, access areas and storage rooms (hospitals, clinics, retirement homes, labs, clean rooms, hotels, restaurants, schools).

Description

- Model: Linea'Punch protection rail
- Height: 180 mm
- Thickness: 25 mm
- Length: 4 m
- Material: 2.5 mm thick PVC, antibacterial and Bs2d0 fire-rated, solid colour
- Surface finish: smooth with central boss
- Fixing components: aluminium brackets (optional: continuous aluminium rail)
- Colours: 31 standard

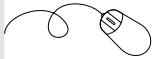

Specification and technical drawings can be downloaded from our website www.gerflor.com

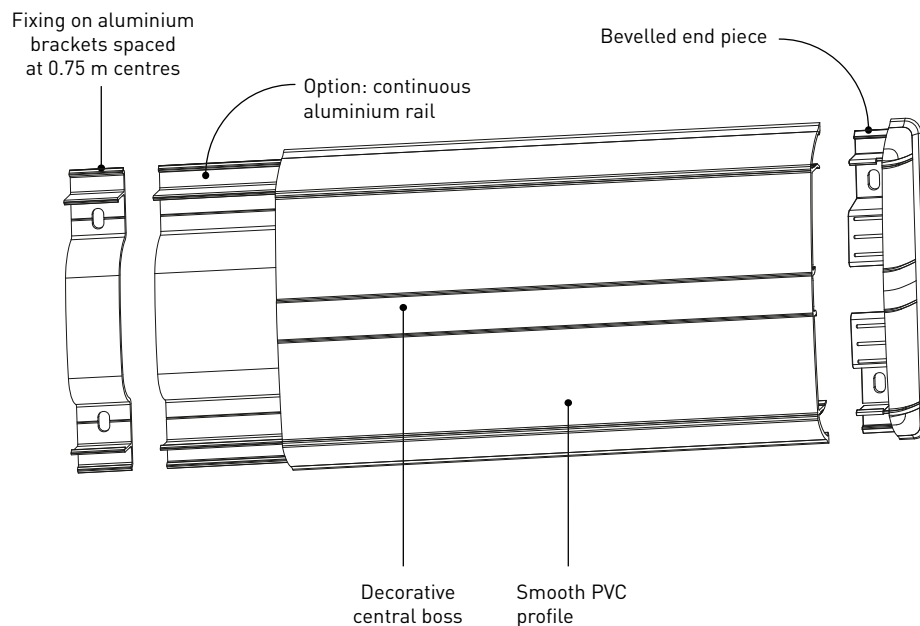

Linea'Punch
31 colours

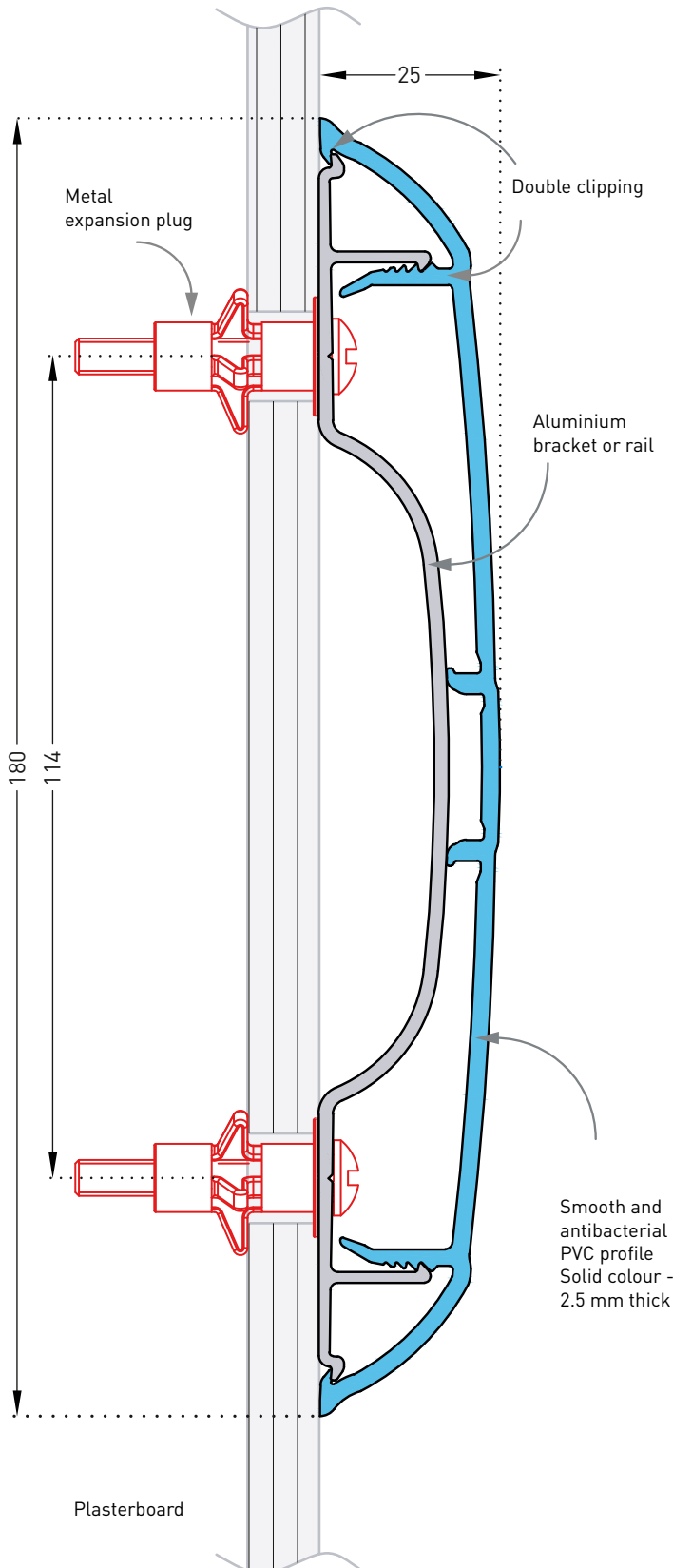

Specification

• **Description:** The selected wall protection rail (Linea'Punch as manufactured by Gerflor) is flat, smooth with a central boss 180 mm deep and projects 25 mm. Its smooth and antibacterial PVC profile is 2.5 mm thick with solid colour. The upper and lower parts of the profile are bevelled and edged with strengthened lips to hold the profile tightly against the wall and minimise dust traps. The ends of these wall protection rails are closed by slim bevelled end-pieces (16.5 mm wide). Wall fixing is by aluminium brackets or continuous rail, made more robust by an exclusive 'omega' shape. A protective film is specified to minimise cleaning before acceptance.

This wall protection rail achieves Bs2d0 fire-rating and an impact resistance in excess of 110 Joules, i.e., an impact of more than 320 kg travelling at 3 kmh.

The LINEA'PUNCH PVC is 100% antibacterial, 100% washable and 100% decontaminable (to level IV on the Institut Pasteur rating).

• **Environment:** Its VOC emissions are very low (level A+), 700 times lower than the European regulatory requirement (VOC over 3 days). No heavy metals are used in its formulation, including lead or tin (insignificant levels, less than 50 ppm) or any CMR Cat 1 or 2 substances, nor PBT/BPA. The calcium-zinc thermal stabilisation process is used and the REACH compliance certificate is required. 100% of the product are recyclable.

• **Colour:** selected by architects from manufacturer's standard range.

The end piece colours are the same as the profile of the wall protection rail.

• **Installation method:** To provide the best protection, the profile's centre-line should be 800 mm above floor level for mid-level wall protection or on top of the skirting for low-level wall protection. It may be clipped to aluminium '4-point' brackets spaced at 750 mm centres (max) or fitted onto a continuous aluminium rail.

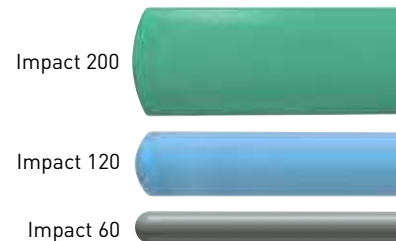

IMPACT



▶ 200/120/60 HEIGHT WALL PROTECTION RAILS

Applications

This horizontal protection system features contoured design to bring you the perfect combination of impact resistance and sheer good looks. Fitted at one or two levels, it protects walls exposed to intensive wheeled traffic in corridors, entrances and storage areas (hospitals, clinics, retirement homes, laboratories, hotels, restaurants, schools, department stores).

Specification

- Description: curved wall protection system made of smooth and antibacterial PVC (Impact 200/120 or 60 as manufactured by Gerflor). PVC rails project 30 mm, are 200/120 or 60 mm deep and snap-fix to aluminium brackets or continuous aluminium core (optional). 3 mm thick, Bs2d0 fire-rated and solid colour, the PVC rails provide a smooth surface finish with decorative grooves. A protective film is specified to minimise cleaning before acceptance. Finish is provided by end pieces, external and internal 90° smooth PVC angle pieces and aluminium joint blocks.
- Environment: No heavy metals and no substance potentially subjected to any REACH restriction are

used in its manufacture, nor PBT/BPA. The calcium-zinc thermal stabilisation process is used. The emission level of volatile substance in inside air has been tested according to ISO 16000-6 and is very low (A+) according to the French regulation (23 March 2011 nr 2011-321 Decree and 19 April 2011 Order). 100% of the product are recyclable.

- Colour: selected by architects from manufacturer's standard range.
- Installation method: recommended height of protection rail centreline 0.80 m above floor level for mid-level wall protection or above plinth for low level wall protection. Snap-fixes to aluminium brackets spaced at 0.75 m centres or continuous aluminium core (optional).

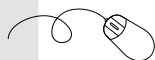

Specification and technical drawings can be downloaded from our website www.gerflor.com

NB: The end piece serves as the first clip.

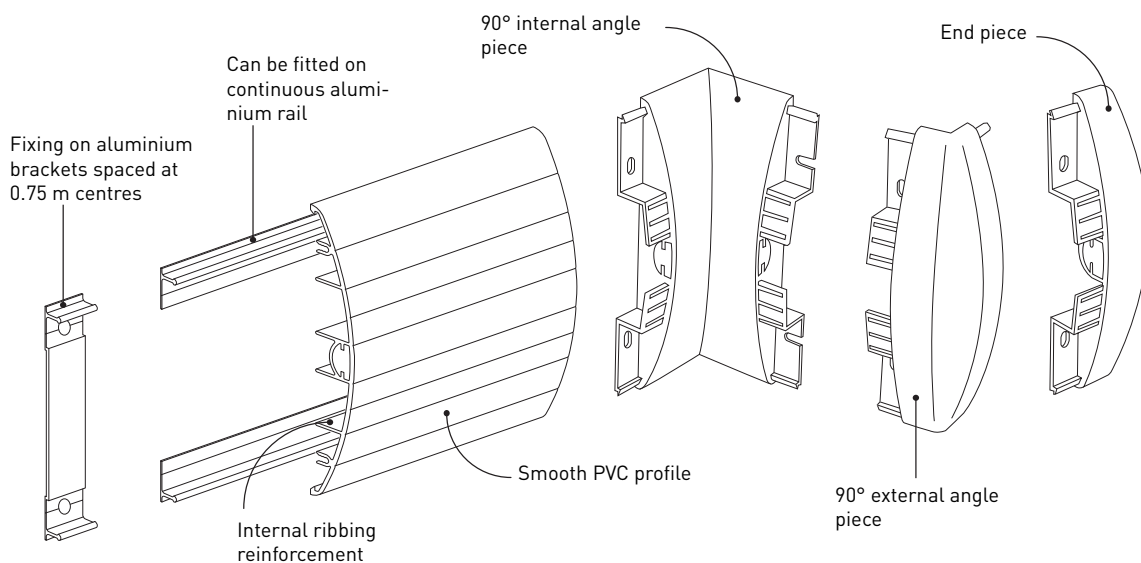

Impact 200/120
31 colours

0000 Chalk	0001 Alum	0002 Flint	0003 Slate	0011 Pebble	0002 Gravel	0003 Clay	0004 Granite	0014 Cinnamon	0009 Sienna	0010 Bark	0005 Schist	0006 Ivory	0007 Wicker	0008 Sand	0012 Grigio
0007 Straw	0002 Apricot	0027 Nelon	0028 Poppy	0013 Sausage grey	0030 Iris	0029 Garnet	0016 Glacier	0018 Azure	0017 Bluebell	0020 Dertin	0024 Bamboo	0023 Meadow	0025 Emerald	0017 Alvaris	

Impact 60
5 colours*

*and 26 colours on request with a minimum order quantity

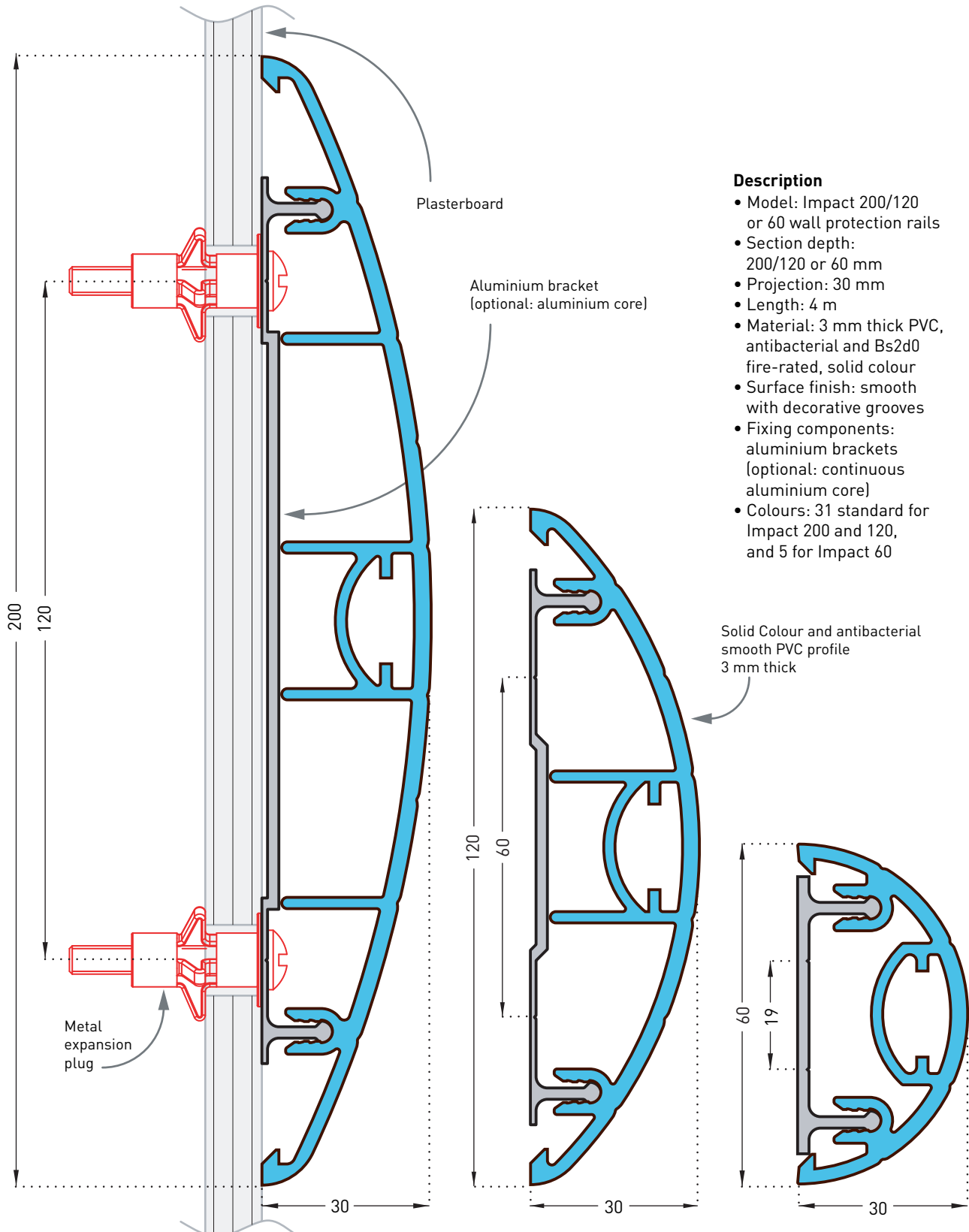

Description

- Model: Impact 200/120 or 60 wall protection rails
- Section depth: 200/120 or 60 mm
- Projection: 30 mm
- Length: 4 m
- Material: 3 mm thick PVC, antibacterial and Bs2d0 fire-rated, solid colour
- Surface finish: smooth with decorative grooves
- Fixing components: aluminium brackets (optional: continuous aluminium core)
- Colours: 31 standard for Impact 200 and 120, and 5 for Impact 60



Contact 350



Contact 200



CONTACT



▶ 350 OR 200 PROTECTION PLATES

Applications

Both resistant and decorative, the Contact protection plates prevent damage to doors and walls exposed to abrasion by furniture, chairs and repeated impact from trolleys in corridors, bedrooms and waiting rooms in clinics and hospitals, schools, universities, hotels, restaurants and offices. It also matches the Impact protection rails.

Specification

- Description: adhesive protection plates (Contact 350 or 200 as manufactured by Gerflor) comprising smooth and antibacterial PVC profiles with a depth of 350 or 200 mm, 2.5 mm thick. PVC profiles achieve Bs2d0 fire rating, feature solid colour and a smooth surface finish with decorative grooves. A protective film is specified to minimise cleaning before acceptance. Sections are delivered with 2 or 3 strips of adhesive foam for fixing.
- Environment: No heavy metals and no substance potentially subjected to any

REACH restriction are used in its manufacture, nor PBT/BPA. The calcium-zinc thermal stabilisation process is used. The emission level of volatile substance in inside air has been tested according to ISO 16000-6 and is very low (A+) according to the French regulation (23 March 2011 nr 2011-321 Decree and 19 April 2011 Order). 100% of the product are recyclable.

- Colour: selected by architects from manufacturer's standard range.
- Installation method: adhesive. Gerflor universal mastic glue is recommended for stronger fixing.

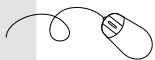

Specification and technical drawings can be downloaded from our website www.gerflor.com

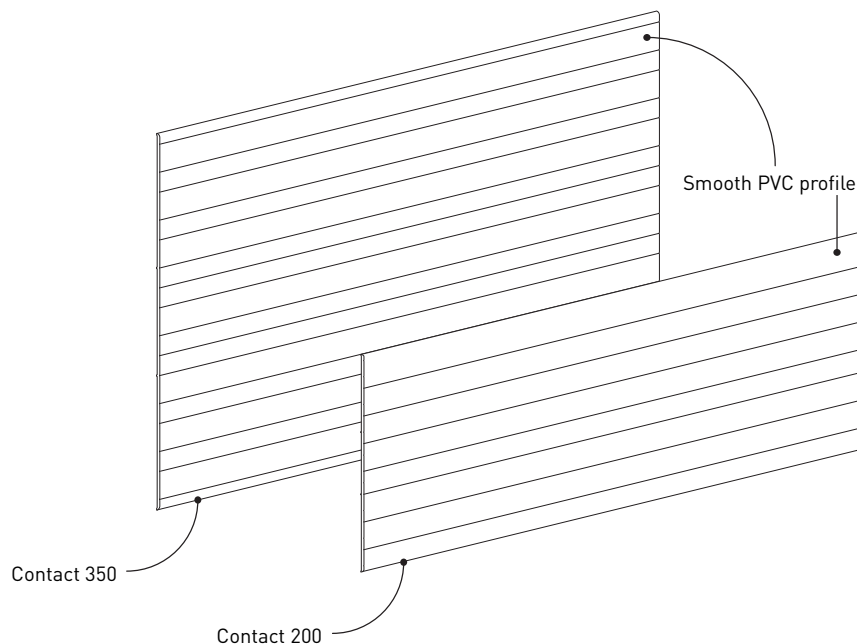

Contact 350
15 colours*



*and 16 colours on request with a minimum order quantity

Contact 200
31 colours

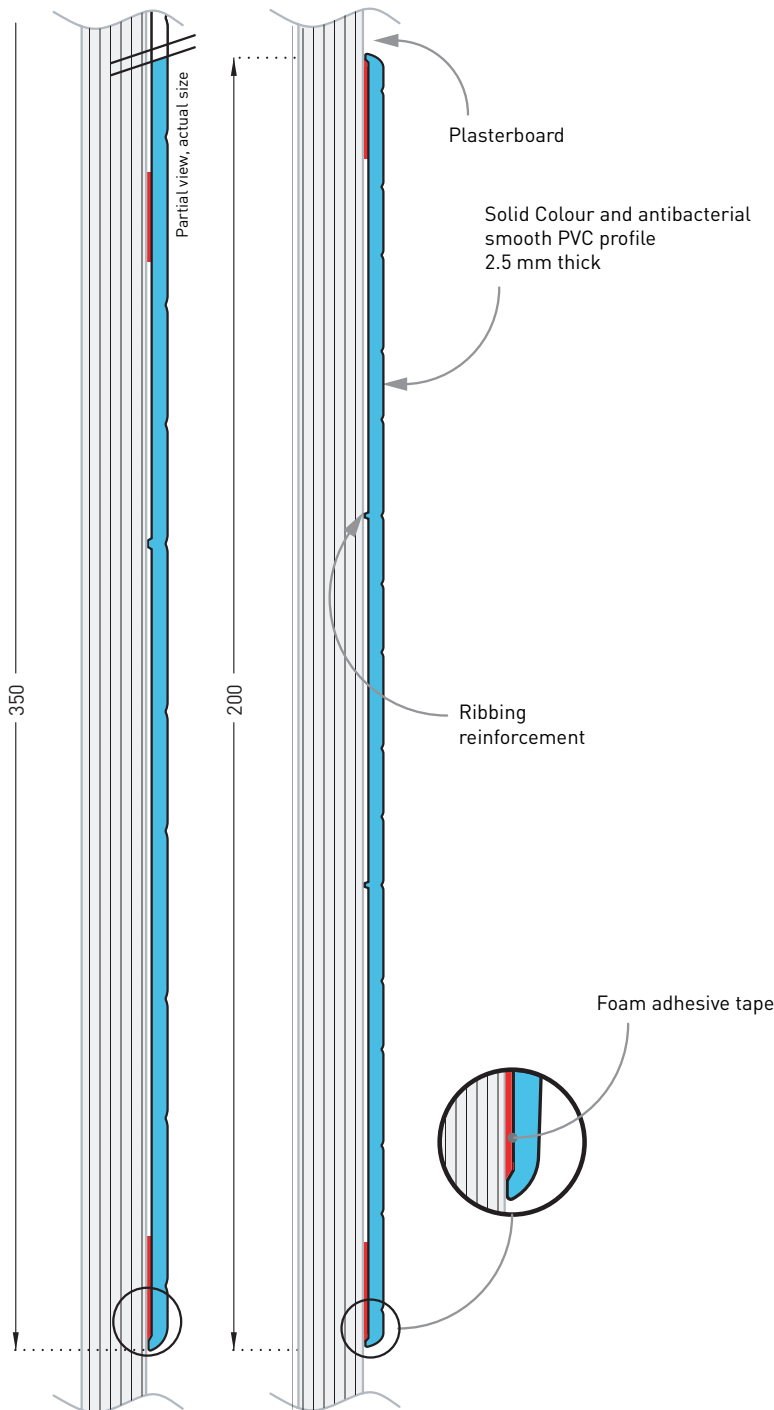

Description

- Model: Contact 350 or 200 adhesive protection plates
- Section depth: 350 or 200 mm
- Thickness: 2.5 mm
- Length: 4 m
- Material: Antibacterial and Bs2d0 fire-rated PVC, solid colour
- Surface finish: smooth with decorative grooves
- Fixing: adhesive foam strips reinforced with Gerflor universal mastic glue
- Colours: 31 standard for Contact 200 and 15 for Contact 350



DECOCHOC



▶ PROTECTION AND COVERING PANEL

Applications

Wall protection for large surfaces in order to cover all parts exposed to impact. This panel can be used in rooms and some corridors (healthcare institutions, schools, etc) and both in operating theatres or clean rooms. The product can be thermoformed for use on round pillars (diameter under 800 mm). Its finish is subtle and matt for a muted, sober appearance with all the usual levels of resistance to impact, scratches, wear and chemical agents.

Description

- Model: Decochoc protection and covering panel
- Standard panel dimensions: 3 m x 1.30 m
- Custom options: cutting to size, bends into L/U, thermoformings, chamfers
- Thickness: 2 mm
- Material: antibacterial and Bs2d0 fire-rated PVC, solid colour
- Surface finish: lightly textured ("Optimixt" grain*)
- Fixing: adhesive bonding with Gerflor acrylic glue or Gerflor universal mastic glue. Joints between panels can be made using silicone joints or PVC welding rods, colour matched to the range
- Colours: 32 standard

Specification

- Description: protection and covering panel (Decochoc as manufactured by Gerflor) from rigid and antibacterial PVC achieving Bs2d0 fire rating with solid colour and textured surface (Optimixt grain as manufactured by Gerflor). 3 m long, 1.30 m wide, 2 mm thick.
- The level required for biocleaning should be validated for very high infectious risk areas such as operating theatres (sector 4) according to the Pasteur Institute of Lille (France). The chemical and mark resistance should have been proved on the usual cleaning products according to ISO 26987. The ease of nuclear decontamination according to ISO 8690 should be excellent.
- Environment: No heavy metals and no substance potentially subjected to any REACH restriction are used in its manufacture, nor PBT/BPA. The calcium-zinc thermal stabilisation process is used. The emission level of volatile substance in inside air has been tested according to ISO 16000-6 and is under 15µg/m³. 100% of the product are recyclable.
- Colour: selected by architects from manufacturer's standard range.
- Installation method: glue as per manufacturer's instructions.



Specification and technical drawings can be downloaded from our website www.gerflor.com

*"Optimixt" grain: optimal combination of scratch resistance, hygiene and aesthetic.

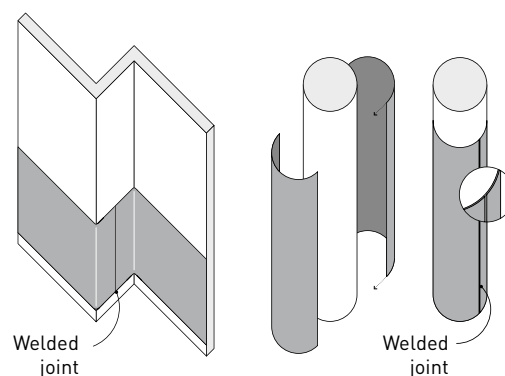
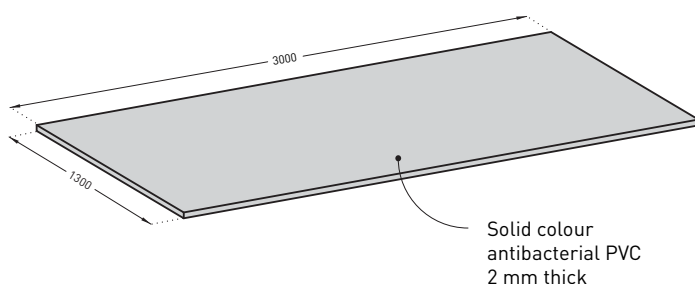

For an impeccable finish:

- Fin'alu: finishing or jointing profiles in satin silver anodised aluminium.



- Fin'Color: finishing and/or jointing profile

- Silicone joints

- Welding rods

colour coordinated with the panels

NEW

Decosmic
3 colours

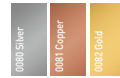

INNOVATION

DECOSMIC



▶ PROTECTION AND COVERING PANEL - METALLIC LOOK

Applications

With their slightly grained, matt surface, Decosmic panels protect and decorate the walls and doors in your premises while also meeting hygiene and impact resistance requirements. The metallic colours designed by SPM will embellish your spaces in an elegant, on-trend way (restaurant, hotel rooms, reception area, etc.) and bring a unique touch to your establishment.

Description

- Model: Decosmic protection and covering panel - metallic look
- Standard panel dimensions: 3 m x 1.30 m
- Custom options: cutting to size, bends into L/U, thermoformings, chamfers
- Thickness: 2 mm
- Material: antibacterial and Bs2d0 fire-rated PVC, solid colour
- Surface finish: lightly textured
- Fixing: adhesive bonding with Gerflor acrylic glue or Gerflor universal mastic glue. Joints between panels can be made using silicone joints or PVC welding rods, colour matched to the range
- Colours: 3 standard

Specification

- Description: protection and covering panel, metallic look (Decosmic as manufactured by Gerflor) from rigid and antibacterial PVC achieving Bs2d0 fire rating with solid colour and textured surface. 3 m long, 1.30 m wide, 2 mm thick.
- The level required for biocleaning should be validated for very high infectious risk areas such as operating theatres (sector 4) according to the Pasteur Institute of Lille (France). The chemical and mark resistance should have been proved on the usual cleaning products according to ISO 26987. The ease of nuclear decontamination according to ISO 8690 should be excellent.
- Environment: No heavy metals and no substance potentially subjected to any REACH restriction are used in its manufacture, nor PBT/BPA. The calcium-zinc thermal stabilisation process is used. The emission level of volatile substance in inside air has been tested according to ISO 16000-6 and is under 15µg/m³. 100% of the product are recyclable.
- Colour: selected by architects from manufacturer's standard range.
- Installation method: glue as per manufacturer's instructions.

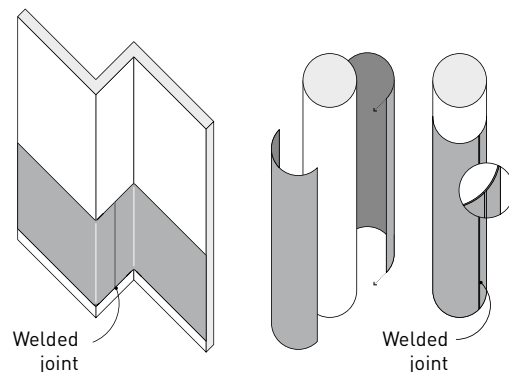
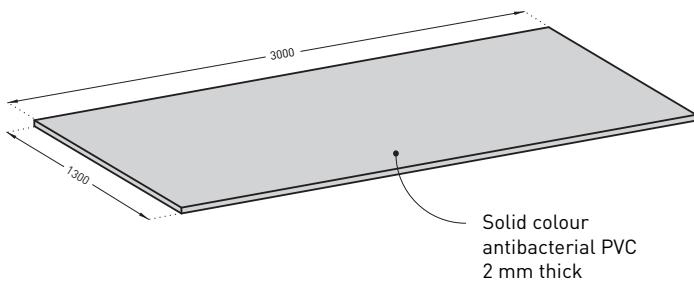

For an impeccable finish:

- Fin'alu: finishing or jointing profiles in satin silver anodised aluminium.
- Silicone joints colour coordinated
- Welding rods with the panels

Wall protection

Find out more about technical solutions at the end of the guide.

To find the colours available for each product, please see the summary table for the range at the end of this guide.



Decowood
7 wood effect finishes



DECOWOOD



▶ WOOD EFFECT DECORATIVE PROTECTION PANEL

Applications

This panel has been designed to protect from impact and abrasion whilst offering the warmth and style of a wood effect finish.

It is particularly adapted to retirements homes, clinics, schools, hotels...

Description

- Model: Decowood decorative protection panel
- Standard panel dimensions: 3 m x 1.30 m
- Thickness: 2 mm
- Material: wood effect Bs2d0 fire-rated PVC
- Surface finish: wood effect
- Fixing: Adhesive bonding with Gerflor acrylic glue or Gerflor universal mastic glue. Joints between panels can be made using silicone joints or PVC welding rods, colour matched to the range.
- Colours: 7 standard wood effect finishes

Specification

- Description: wood effect decorative protection panel (Decowood as manufactured by Gerflor). Impact and scratch resistant from rigid wood effect PVC Bs2d0 fire-rated. Its length is 3 m, width 1.30 m and thickness 2 mm.
- Environment: No heavy metals and no substance potentially subjected to any REACH restriction are used in its manufacture, nor PBT/BPA. The calcium-zinc thermal stabilisation process is used. The emission level of volatile substance in inside air has been tested according to ISO 16000-6 and is very low (A+) according to the French regulation (23 March 2011 nr 2011-321 Decree and 19 April 2011 Order). 100% of the product are recyclable.
- Colours: selected by architects from manufacturer's standard range.
- Installation method: Glue as per manufacturer's instructions.



Specification can be downloaded from our website www.gerflor.com

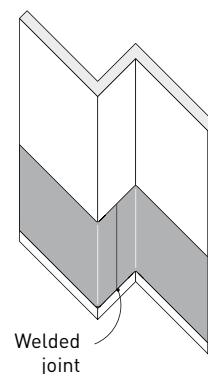
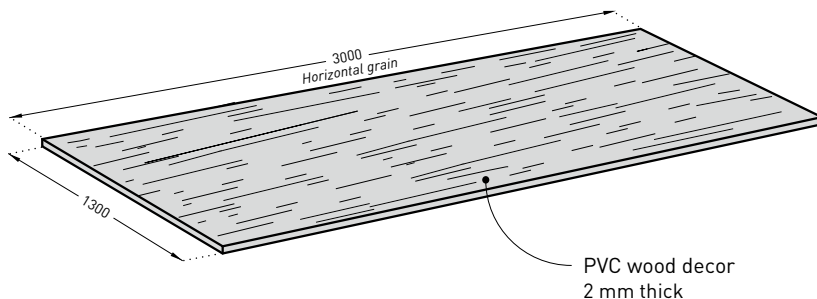



Decotrend
4 trend decors

DECOTREND



▶ TREND EFFECT DECORATIVE PROTECTION PANEL

Applications

This range of panels uplifts and highlights interiors in an original manner and fits into a modern and urban design. Their high degree of strength is useful for covering walls of bedrooms, reception areas and dining areas in hotels, retirement homes, schools or any form of establishment open to the public.

Description

- Model: Decotrend decorative protection panel (Composite or Brushed Aluminium)
- Standard panel dimensions: 3 m x 1.30 m
- Thickness: 2 mm
- Material: trend decor Bs2d0 fire-rated PVC
- Surface finish: metalized or concrete effect
- Fixing: Adhesive bonding with Gerflor acrylic glue or Gerflor universal mastic glue. Joints between panels can be made using silicone joints or PVC welding rods, colour matched to the range.
- Colours: 4 standard decors

Specification

- Description: trend effect decorative protection panel (Decotrend as manufactured by Gerflor - Composite or Brushed Aluminium or Concrete). Impact and scratch resistant from rigid metalized or concrete effect PVC Bs2d0 fire-rated. Its length is 3 m, width 1.3 m and thickness 2 mm.
- Environment: No heavy metals and no substance potentially subjected to any REACH restriction are used in its manufacture, nor PBT/BPA. The calcium-zinc thermal stabilisation process is used. The emission level of volatile substance in inside air has been tested according to ISO 16000-6 and is very low (A+) according to the French regulation (23 March 2011 nr 2011-321 Decree and 19 April 2011 Order). 100% of the product are recyclable.
- Colour: selected by architects from manufacturer's standard range.
- Installation method: Glue as per manufacturer's instructions.

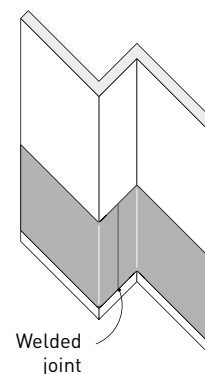
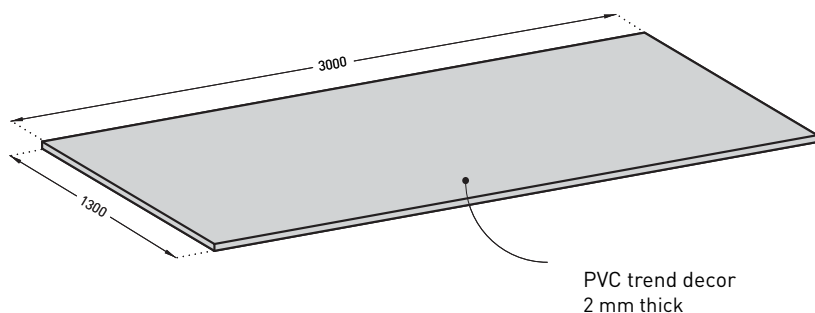

Find out more about technical solutions at the end of the guide.

To find the colours available for each product, please see the summary table for the range at the end of this guide.

Decoclean
5 colours

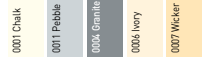

DECOCLEAN



▶ SMOOTH PROTECTION PANEL

Applications

This wall protection has been especially developed for areas exposed to a high risk of infection in order to help in the fight against in-hospital illnesses and to reduce bacterial proliferation. It is recommended for:

- Operating theatres
- Intensive care, transplant and serious burns wards
- Neonatology
- Central sterilisation
- All high infection risk areas, including those at Level 4 on the Pasteur scale.

Description

- Model: Decoclean smooth protection panel
- Standard panel dimensions: 3 m x 1.30 m
- Custom options: cutting to size, bendings, chamfers
- Thickness: 2 mm
- Material: Antibacterial and Bs2d0 fire-rated PVC, solid colour
- Surface finish: smooth
- Fixing: Adhesive bonding with Gerflor acrylic glue or Gerflor universal mastic glue. Joints between panels can be made using silicone joints or PVC welding rods, colour matched to the range
- Colours: 5 standard

Specification

- Description: smooth protection panel (Decoclean as manufactured by Gerflor) in rigid and antibacterial PVC, Bs2d0 fire-rated and solid-coloured. Its surface is smooth. Its length is 3 m, width 1.30 m and thickness 2 mm. A protective film must protect the panel during the whole installation time. The level required for biocleaning should be validated for very high infectious risk areas such as operating theatres (sector 4) according to the Pasteur Institute of Lille (France). The chemical and mark resistance should have been proved on the usual cleaning products according to ISO 26987. The ease of nuclear decontamination according to ISO 8690 should be excellent.
- Environment: No heavy metals and no substance potentially subjected to any REACH restriction are used in its manufacture, nor PBT/BPA. The calcium-zinc thermal stabilisation process is used. The emission level of volatile substance in inside air has been tested according to ISO 16000-6 and is under $15\mu\text{g}/\text{m}^3$. 100% of the product are recyclable.
- Colour: selected by architects from manufacturer's standard range.
- Installation method: glue as per manufacturer's instructions.

Specification and technical drawings can be downloaded from our website www.gerflor.com

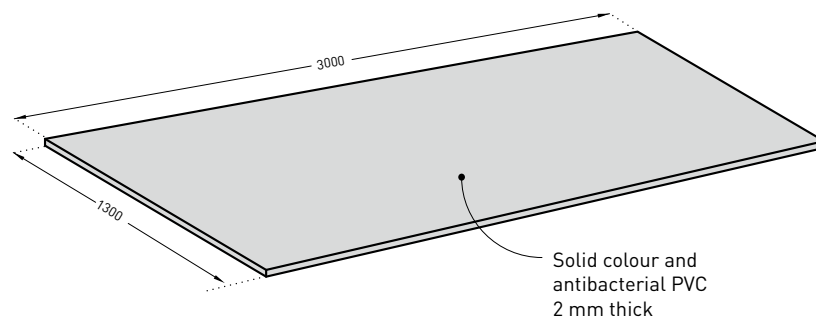

For an impeccable finish:

- Silicone joints — colour coordinated with the panels
- Welding rods

Find out more about technical solutions at the end of the guide.

To find the colours available for each product, please see the summary table for the range at the end of this guide.

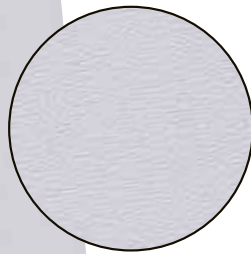

NEW
Decochoc H₂O
5 colours

1101 Niere	1102 Spume	1103 Shell	1104 Dune	1105 Sea spray
------------	------------	------------	-----------	----------------

INNOVATION

DECOCHOC H₂O



Wall protection

▶ PROTECTION AND COVERING PANEL FOR WET AREAS

Applications

Panel specially designed to protect walls and doors in wet rooms (bathrooms, toilets, kitchens, etc.). Its finely grained, matt surface provides optimal water repellency and scratch resistance. The formulation is specifically developed to ensure an optimum fusion of panels and skirting with the H₂O welding rod. This system provides total watertightness, approved by the CSTB and certified by an ATEX (Technical Evaluation of Experimentation). Gerflor offers a line of welding rods matching the profile colours.

Description

- Model: Decochoc H₂O protection and covering panels for wet areas
- Standard panel dimensions: 2.50 m x 1.30 m
- Custom options: cutting to size, bends into L/U, thermoformings, chamfers
- Thickness: 1.5 mm
- Material: antibacterial and Bs2d0 fire-rated PVC, solid colour
- Surface finish: slightly textured. Specific wet area Hydr'X grain
- Fixing: adhesive bonding with Gerflor acrylic glue. Joints between panels should be made using PVC welding rods, colour matched to the range.
- Colours: 5 standard.

Specification

- Description: protection and covering panel for wet areas (Decochoc H₂O as manufactured by Gerflor) from rigid and antibacterial PVC achieving Bs2d0 fire-rating with solid colour. Its surface is slightly textured with a fine and matte grain finish (Hydr'X grain as manufactured by Gerflor) perfectly suitable for wet areas due to its water-repellent qualities that limit the development of scale while ensuring optimal scratch resistance. 2.50 m long, 1.30 m wide, 1.5 mm thick. To ensure watertightness of the system, the panels are thermo-welded to each other and to the PVC skirting by means of a welding rod (H₂O welding rod as manufactured by Gerflor). Any connections with other materials are made with a silicone joint (H₂O silicone joint as manufactured by Gerflor). The behaviour of the system in wet areas has been validated and has ATEX certification issued by the CSTB. The chemical and mark resistance of the panel should have been proven on the usual cleaning products according to ISO 26987.
- Environment: no heavy metals are used in its formulation, including lead and tin (insignificant levels, less than 50 ppm) or any CMR Cat 1 or 2 substances, nor PBT/BPA. The calcium-zinc thermal stabilisation process is used. The emission level of volatile substance in inside air has been tested (less than 15µg/m³) according to ISO 16000-6 and is very low (A+) according to the French regulation (23 March 2011 nr 2011-321 Decree and 19 april 2011 Order). 100 % of the product is recyclable.
- Colours: selected by architects from manufacturer's standard range.
- Installation method: glue as per manufacturer's instructions. The installer must have been trained beforehand by the manufacturer to install this system.

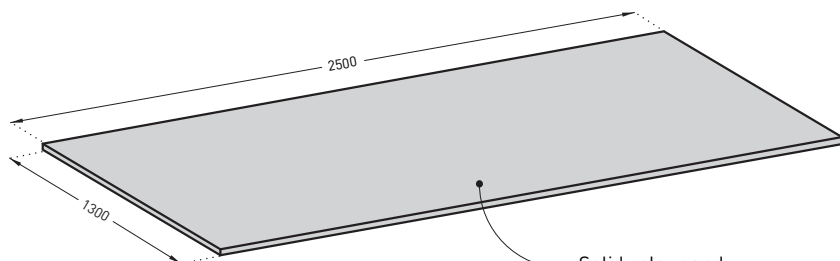

Solid colour and antibacterial PVC
1,5 mm thick

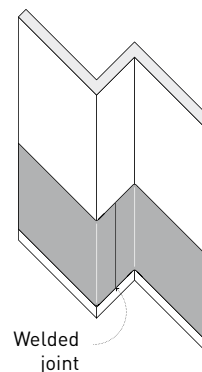

For an impeccable and perfectly watertight finish:

- Welding rods H₂O _____ colour coordinated with the panels
- Silicone joints H₂O _____

Find out more about technical solutions at the end of the guide.

To find the colours available for each product, please see the summary table for the range at the end of this guide.



FIN'ALU



FINISHING AND JOINTING PROFILES FOR 2 MM PANELS DECOCHOC, DECOSMIC, DECOWOOD AND DECOTREND PANELS

Applications

Fin'alu profiles are designed to finish or joint Decochoc, Decosmic, Decowood and Decotrend protection panels and to bring a decorative and up-market original touch. They provide a perfect finish in low-traffic corridors, waiting rooms or bedrooms. They fit into healthcare facilities (hospitals, clinics, retirement homes) as well as hotels and service sector.

Description

- Model: Fin'Alu finishing (J shape) or jointing (H shape) profile for 2 mm thick panels
- Width (covering): 18 mm (37.5 mm hidden part) for finishing profile; 42 mm (55 mm hidden part) for joint profile
- Length: 3 m
- Material: satin silver anodised aluminium
- Surface finish: smooth
- Fixing: adhesive bonding with Gerflor acrylic glue or screwing to wall
- Colour: satin silver anodised

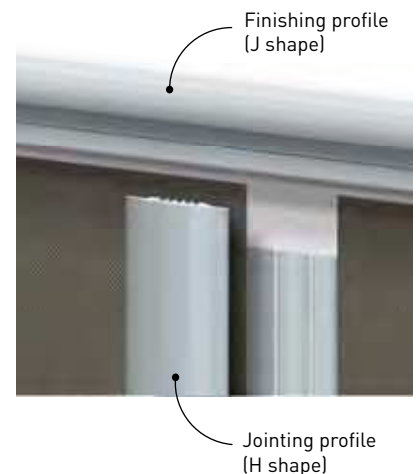

Specification

1 Description: Finishing profile (J shape) in satin silver anodised aluminium (Fin'Alu finishing profile in J shape as manufactured by Gerflor) designed for vertical or horizontal finishing for 2 mm thick protection panels (Decochoc, Decosmic, Decowood or Decotrend as manufactured by Gerflor). Smooth surface, 3 m long, 18 mm wide for the visible part and 37.5 mm for the hidden part fixed to the wall.

- Colour: Selected by architects from manufacturer's standard range.
- Installation method: glue as per manufacturer's instructions or screwing to wall.

2 Description: Jointing profile (H shape) in satin silver anodised aluminium (Fin'Alu jointing profile in H shape as manufactured by Gerflor) designed for vertical or horizontal jointing between 2 mm thick protection panels (Decochoc, Decosmic, Decowood or Decotrend as manufactured by Gerflor). Smooth surface. The profile, 3 m long and 42 mm wide (visible part) snap fixes onto the continuous aluminium rail, 55 mm wide (hidden part).

- Colour: Selected by architects from manufacturer's standard range.
- Installation method: snap-fixing onto aluminium rail to glue to wall as per manufacturer's instructions.

1 Finishing profile (into J shape)

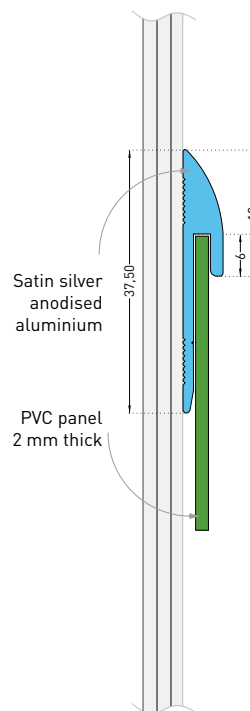

2 Jointing profile (into H shape)

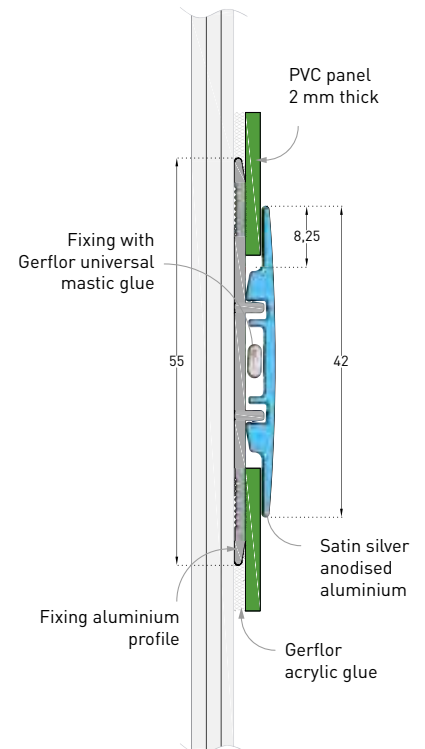

Find out more about technical solutions at the end of the guide.

To find the colours available for each product, please see the summary table for the range at the end of this guide.

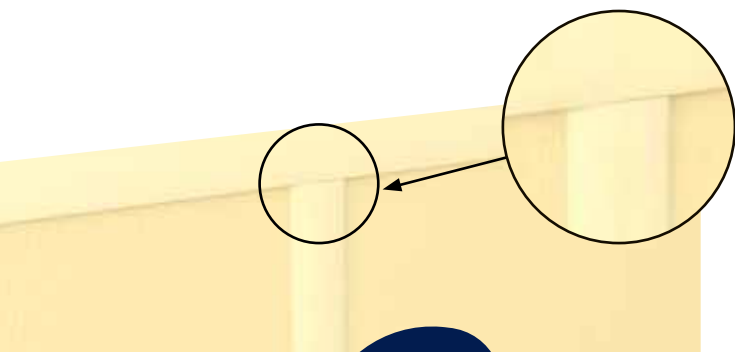

Fin'Color
32 colours



NEW

FIN'COLOR

NEW



FINISHING AND/OR JOINTING PROFILE FOR 2 MM PANELS DECOCHOC, DECOCLEAN, DECOWOOD AND DECOTREND

Applications

Fin'Color is a multi-purpose PVC profile that provides an aesthetic finish and a perfect joint between panels or between panel and floor skirting. Available in all colours in the range, to be matched with our protection panels, it brings a subtle decorative touch for a harmonious whole. It is suitable for low traffic areas, enhancing all types of public buildings.

Description

- Model: Fin'Color finishing and/or jointing profile for 2 mm thick panels
- Width (visible part): 20.5 mm
- Length: 3 m
- Material: antibacterial and Bs2d0 fire-rated PVC, solid colour
- Surface finish: smooth
- Fixing : adhesive bonding with Gerflor acrylic glue or Gerflor universal mastic glue
- Colours: 32 standard

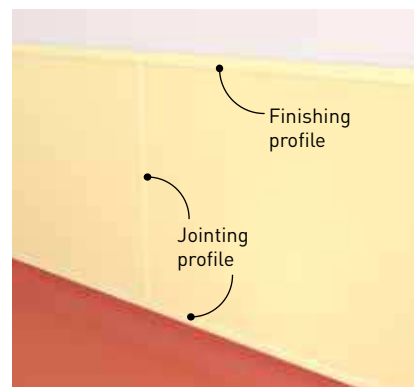

Specification

• Description: finishing and/or jointing profile from antibacterial PVC achieving Bs2d0 fire rating with solid colour (Fin'Color as manufactured by Gerflor) designed to provide horizontal or vertical finishing for 2 mm thick protection panels (Decochoc, Decoclean, Decowood or Decotrend as manufactured by Gerflor) or the connection of these panels with 2 mm flexible floor skirting.

Its surface is smooth. It is 3 m long, 20.5 mm wide for the visible part.

• Environment: no heavy metals are used in its formulation, including lead or tin (insignificant levels, less than 50 ppm) or any CMR Cat 1 or 2 substances, nor PBT/BPA. The Calcium-zinc thermal stabilisation process is used. The emission level of volatile substance in inside air has been tested according to ISO 16000-6 and is very low (A+) according to the French regulation (23 March 2011 nr 2011-321 Decree and 19 April 2011 Order).

100 % of the product are recyclable.

- Colours: selected by architects from manufacturer's standard range.
- Installation method: glue as per manufacturer's instructions.

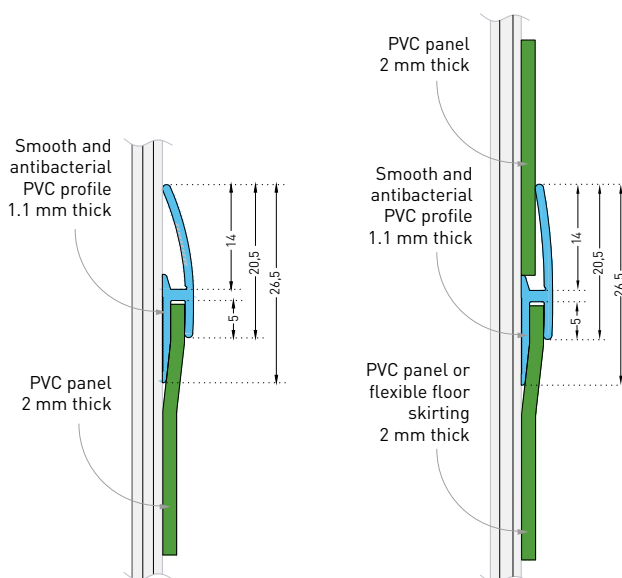
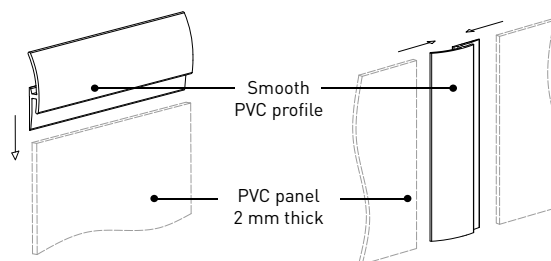

Finishing

Jointing

Find out more about technical solutions at the end of the guide.

To find the colours available for each product, please see the summary table for the range at the end of this guide.



DECOFRESC



▶ ALL PUBLIC CONTEMPORARY

Applications

The contemporary Decofresc decorative frescoes provide an attractive setting in public buildings. They bring a touch of elegance and customization while protecting walls and they meet hygiene and impact resistance requirements.

Description

- Model: All public contemporary Decofresc decorative protection fresco
- Standard panel dimensions: 3 m x 1.30 m indivisible
- Thickness : 2 mm
- Material : Antibacterial and Bs2d0 fire-rated PVC, solid colour
- Surface finish: lightly textured ("Optimixt" grain*)
- Fixing: adhesive bonding with Gerflor acrylic glue or Gerflor universal mastic glue. Joints between panels can be made using silicone joints or PVC welding rods, colour matched to the range.
- Colours: 32 standard.

*"Optimixt" grain: optimal combination of scratch resistance, hygiene and aesthetic.

Specification

- Description: decorative protection fresco (Cloud or Wave Decofresc as manufactured by Gerflor) from rigid and antibacterial PVC achieving Bs2d0 fire rating with solid colour and textured surface (Optimixt grain as manufactured by Gerflor). 3 m long, 1.30 m wide (indivisible), 2 mm thick.
- Environment: No heavy metals and no substance potentially subjected to any REACH restriction are used in its manufacture, nor PBT/BPA. The calcium-zinc thermal stabilisation process is used. The emission level of volatile substance in inside air has been tested according to ISO 16000-6 and is under 15µg/m³. 100% of the product are recyclable.
- Colour: selected by architects from manufacturer's standard range
- Installation method: glue as per manufacturer's instructions.



Wave



Cloud

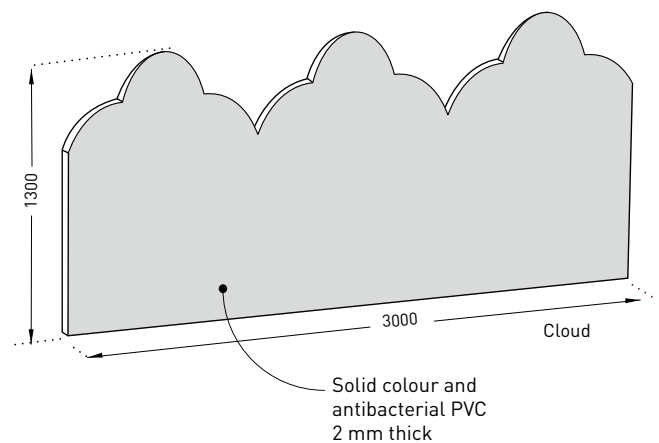



DECOFRES



▶ EARLY CHILDHOOD

Applications

The early childhood Decofresc decorative frescoes are especially designed to brighten up and durably protect walls in establishments who hope to create an attractive, welcoming atmosphere that stimulates children's imagination. They meet the constraints linked to the early childhood: hygiene and impact resistance.

Description

- Model: Early childhood Decofresc decorative protection fresco
- Standard panel dimensions: 3 m x 1.30 m indivisible
- Thickness : 2 mm
- Material : Antibacterial and Bs2d0 fire-rated PVC, solid colour
- Surface finish: lightly textured ("Optimixt" grain*)
- Fixing: adhesive bonding with Gerflor acrylic glue or Gerflor universal mastic glue. Joints between panels can be made using silicone joints or PVC welding rods, colour matched to the range.
- Colours: 3 themes each with 4 pictures (fixed colours).

*"Optimixt" grain: optimal combination of scratch resistance, hygiene and aesthetic.

Specification

- Description: decorative protection fresco (Savannah, Maritime or Altitude Decofresc as manufactured by Gerflor) from rigid and antibacterial PVC achieving Bs2d0 fire rating with solid colour and textured surface (Optimixt grain as manufactured by Gerflor). 3 m long, 1.30 m wide (indivisible), 2 mm thick.
- Environment: No heavy metals and no substance potentially subjected to any REACH restriction are used in its manufacture, nor PBT/BPA. The calcium-zinc thermal stabilisation process is used. The emission level of volatile substance in inside air has been tested according to ISO 16000-6 and is under 15µg/m³. 100% of the product are recyclable.
- Colour: selected by architects from manufacturer's standard range
- Installation method: glue as per manufacturer's instructions.



Altitude theme (4 pictures)



Savannah theme (4 pictures)



Maritime theme (4 pictures)

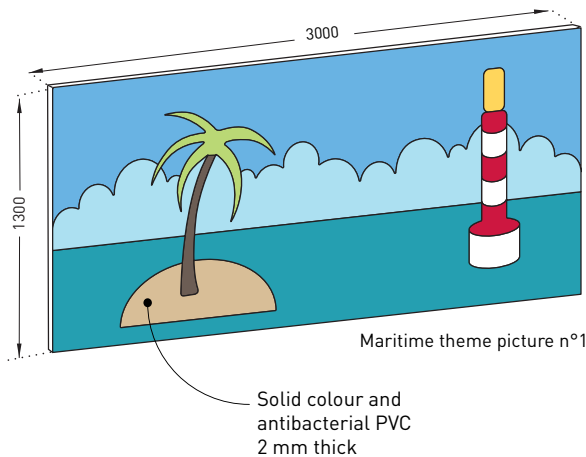

Maritime theme picture n°1

Find out more about technical solutions at the end of the guide.

To find the colours available for each product, please see the summary table for the range at the end of this guide.



DECOPRINT 2 OR 1 MM



PROTECTION OR DECORATION PANEL WITH CUSTOMIZED DIGITAL PRINTING

Applications

The Decoprint printed panel is the original solution created and developed by Gerflor to combine customized wall protection (2 mm) and/or decoration (1 mm).

We custom-build your protection and/or decoration panel, using digital printing to place your image (photograph, drawing, logo, text, etc.) on the back of the panel, in the requested size.

It is also possible to link images to provide a continuous image. In 2 mm thick, this is the ideal protection to enhance a touch of elegance and originality in buildings looking for aesthetic or signage solutions to cover walls in form.

The 2 mm Decoprint panel creates a welcoming environment while guaranteeing durable and optimal protection and meets the hygiene and impact resistance requirements necessary in buildings that are open to the public.

Description

- Model: Decoprint protection (2 mm) or decoration (1 mm) panel with digital printing
- Height: made-to-measure (maximum 1.20 m)
- Width: made-to-measure (maximum 2.90 m)
- Thicknesses: 2 mm or 1 mm
- Material: Translucent antibacterial and Bs2d0 fire-rated PVC with image printed on the back
- Surface finish: lightly textured ("Optimix" grain* in 2 mm or "Velvet" grain in 1 mm)
- Fixing: adhesive bonding with Gerflor acrylic glue or Gerflor universal mastic glue. Joints between panels can be made using silicone joints or PVC welding rods, colour matched to the range.
- Colours: translucent for customization.

***"Optimix" grain: optimal combination of scratch resistance, hygiene and aesthetic.*

Specification

- Description: protection (2 mm) or decoration (1 mm) panel with customized digital printing (Decoprint as manufactured by Gerflor) from translucent antibacterial PVC achieving Bs2d0 fire rating with images printed on the back. The surface is lightly textured ("Optimix" grain in 2 mm or "Velvet" grain in 1 mm as manufactured by Gerflor). Its maximum height is 1.20 m and its maximum length is 2.90 m and 2 mm thick (protection) or 1 mm thick (decoration).
- Environment: No heavy metals and no substance potentially subjected to any REACH restriction are used in its manufacture, nor PBT/BPA. The calcium-zinc thermal stabilisation process is used. The emission level of volatile substance in inside air has been tested according to ISO 16000-6 and is under 15µg/m³. 100% of the product are recyclable.
- Colours: customized and selected by architects**
- Installation: glue as per manufacturer's instructions.

***The reproduced images or photos, provided by the user in accordance with Gerflor requested specification, must be free of copyright - if they are not, the reproduction rights are payable by the user, who has full responsibility.*

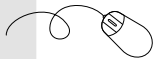

Specification and technical drawings can be downloaded from our website www.gerflor.com

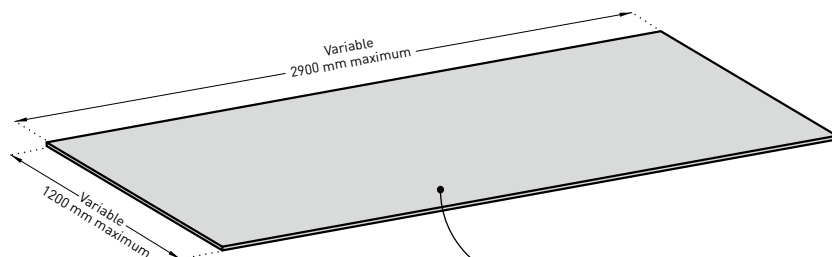

Antibacterial PVC
2 mm thick (protection)
or 1 mm thick (decoration)

▶ GERFLOR CARRIES OUT YOUR CUSTOMIZED PANEL

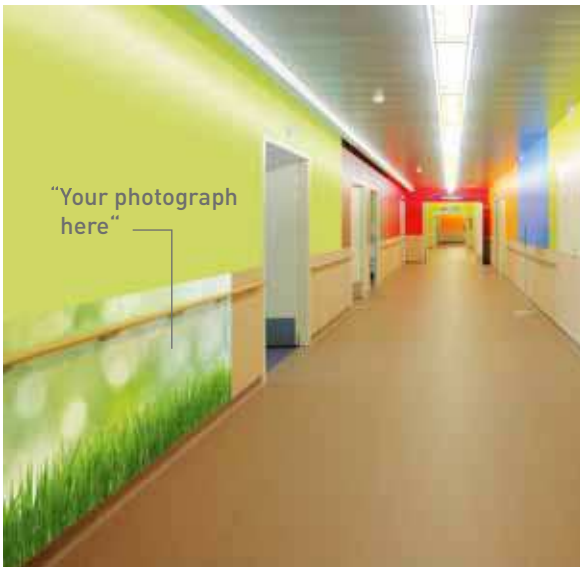

Call our local service for answers to all your questions and to create a customized panel.

The reproduced images or photos, provided by the user in accordance with Gerflor requested specification, must be free of copyright – if they are not, the reproduction rights are payable by the user, who has full responsibility.

Find out more about technical solutions at the end of the guide.



DECOCARE



▶ HAND HYGIENE PANEL

Applications

Decocare hand hygiene panels combine a public health message with effective protection of the walls above sinks.

The educational pictograms are easy to understand and encourage good hand hygiene in order to limit the spread of hand-borne germs.

The panels provide decorative wall protection and can be installed in all wet rooms to spell out the hand washing routine. They can also be customized with your logo or other text.

Description

- Model: Decocare hand hygiene panel
- Dimensions:
Classic: 600 x 400 mm
Fountain: 600 x 600 mm
Made-to-measure
- Thickness: 1 mm
- Material: Translucent antibacterial Bs2d0 fire-rated PVC with image printed on the back
- Surface finish: lightly textured ("Velvet" grain)
- Fixing: adhesive bonding with Gerflor acrylic glue or Gerflor universal mastic glue.
- Colours:
2 standard models
Option: customization

Specification

- Description: Hand hygiene panel, classic or fountain shape (Decocare as manufactured by Gerflor) from translucent antibacterial PVC achieving Bs2d0 fire rating with image printed on the back. Its surface is lightly textured ("Velvet" grain as manufactured by Gerflor). Its length is 600 mm, its height is 400 mm (classic) or 600 mm (fountain) and its thickness is 1 mm.
- Environment: No heavy metals and no substance potentially subjected to any REACH restriction are used in its manufacture, nor PBT/BPA. The calcium-zinc thermal stabilisation process is used. The emission level of volatile substance in inside air has been tested according to ISO 16000-6 and is under 15µg/m³. 100% of the product are recyclable.
- Colour: selected by architects from manufacturer's standard range. Customized on request.
- Installation method: glue, as per manufacturer's instructions.

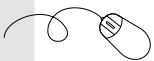

Specification and technical drawings can be downloaded from our website www.gerflor.com

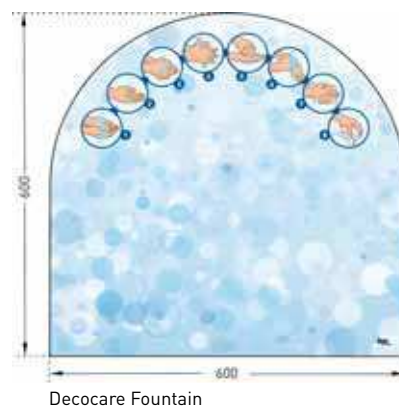
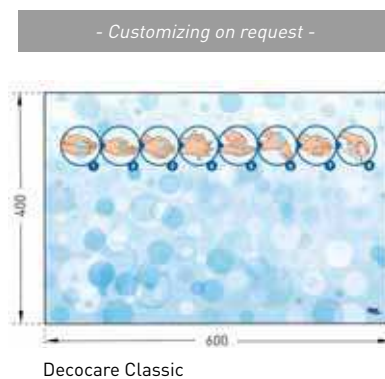



DECOKID



▶ EDUCATIONAL PANEL

Applications

Gerflor's educational panels Decokid bring to life a number of messages in bright colours, aimed at children, whilst still providing wall protection. Putting across educational principles to small children by means of immediately understandable images within their school environment is an effective educational aid. Hygiene, the environment, safety, etc. Gerflor's educational panels illustrate real situations that relate to children's daily lives.

Description

- Model: Decokid Educational panel
- Standard panel dimensions: 0.75 m x 1.30 m
- Thickness: 1 mm
- Material: Translucent antibacterial and Bs2d0 fire-rated PVC, with a visual printed on the back
- Surface finish: Lightly textured ("Velvet" grain)
- Fixing: Adhesive bonding with Gerflor acrylic glue or with Gerflor universal mastic glue
- Colours: 11 designs available (in predefined colours)

Specification

- Description: Educational panel (Decokid as manufactured by Gerflor) from rigid, antibacterial and translucent PVC achieving Bs2d0 fire rating with a visual printed on the back. The surface is lightly textured ("Velvet" grain as manufactured by Gerflor). Its width is 0.75 m, height 1.30 m and thickness 1 mm.
- Environment: No heavy metals and no substance potentially subjected to any REACH restriction are used in its manufacture, nor PBT/BPA. The calcium-zinc thermal stabilisation process is used. The emission level of volatile substance in inside air has been tested according to ISO 16000-6 and is under 15µg/m³. 100% of the product are recyclable.
- Colour: selected by architects from manufacturer's standard range
- Installation method: glue, as per manufacturer's instructions.

Specification and technical drawings can be downloaded from our website www.gerflor.com



1. I cross the road at a pedestrian crossing.



2. Early to bed, early to rise.



3. 30 mph, that's the urban speed limit.



4. I always say, 'Hello'.



5. I always put my rubbish in the bins provided.



6. I always wash my hands before eating.



7. I always wear my seat belt in the car.



8. I take breaks from my video games.



9. I always wash my hands after using the toilets.



10. No pushing.



11. I never leave the tap running.

Educational panels: a unique and original concept

- Matched to all existing colour schemes
- Extends a building's working life
- Resists damage from even the harshest cleaning materials
- Easy to install
- These panels match the Decochoc protection and covering panels (available in 32 colours) for optimal protection

Find out more about technical solutions at the end of the guide.

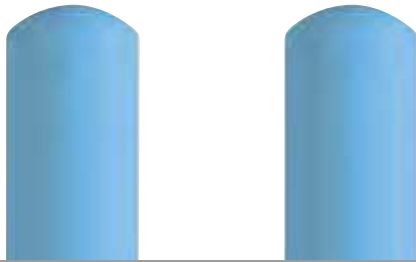

Bedkit
31 colours

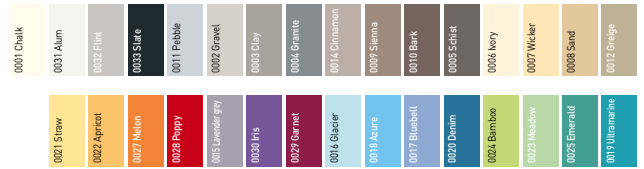

BEDKIT



▶ VERTICAL BED HEAD PROTECTION

Applications

This protection has been especially designed to protect walls from bed-heads impacts in all health buildings.

Description

- Model: Bedkit vertical bed-head protection
- Height: 600 mm
- Thickness: 30 mm
- Projection: variable from 146 to 336 mm
- Material: 3 mm antibacterial and Bs2d0 fire-rated PVC, solid colour
- Surface finish: smooth with decorative grooves
- Fixing: of the aluminium plate with 8 metal expansion plugs
- Colours: 31 standard

Specification

- Description: bed head protection comprising 2 vertical wall protection rails, on aluminium plate and 2 aluminium tubes (Bedkit as manufactured by Gerflor). Bs2d0 fire-rated, antibacterial and solid colour, the PVC rails provide a smooth surface with decorative grooves and are fixed on a 3 mm thick and 600 mm high aluminium plate. These parts fit together on 2 coated aluminium tubes adjustable from 110 to 300 mm, fixed by a tightening screw and fitted to the wall with a 3 mm thick aluminium plate. Overall projection is adjustable from 146 mm to 336 mm. A protective film is specified to minimise cleaning before acceptance.
- Environment: No heavy metals and no substance potentially subjected to any REACH restriction are used in its manufacture, nor PBT/BPA. The calcium-zinc thermal stabilisation process is used. The emission level of volatile substance in inside air has been tested according to ISO 16000-6 and is very low (A+) according to the French regulation (23 March 2011 nr 2011-321 Decree and 19 April 2011 Order). 100% of the product are recyclable.
- Colour: selected by architects from manufacturer's standard range.
- Installation method: fixing the aluminium plate with 8 metal expansion plugs.

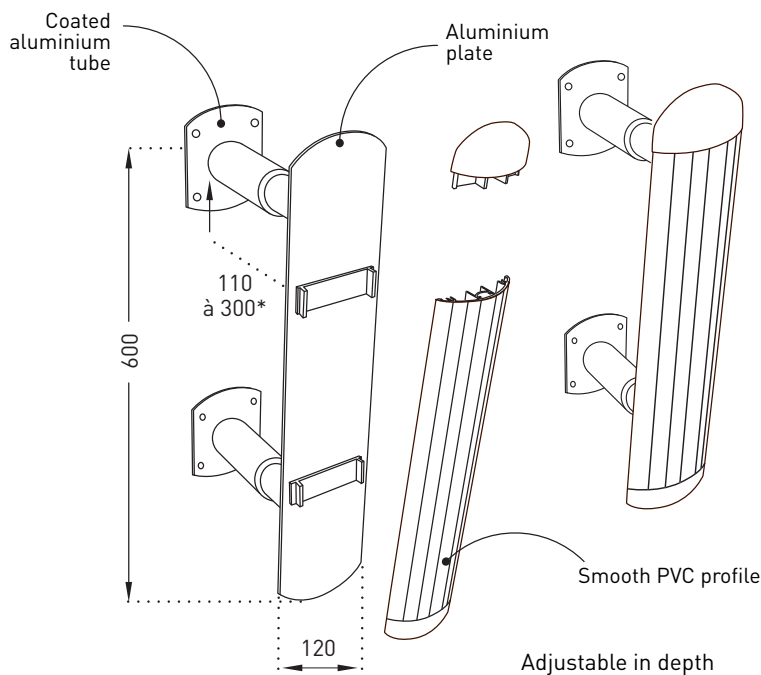

* A cutting of the tubes is required to obtain an interval from 110 to 256 mm.

Specification and drawings
can be downloaded from our website
www.gerflor.com



Plac'Inox

PLAC'INOX



▶ BRUSHED STAINLESS STEEL PROTECTION PLATE

Applications

Plac'Inox protection plates reinforce those areas subject to impacts and are approved for food-handling areas. Suitable for use in areas of heavy use or damp places, they are particularly useful in the food and pharmaceutical industries as well as in healthcare establishments, main kitchens, etc.

Description

- Model: Plac'Inox protection plate
- Height: as required (1.25 m maximum)
- Length: as required (2.50 m maximum)
- Thickness: 10/10th mm
- Material: Stainless steel (approved for food handling areas)
- Fixing: Adhesive bonding with Gerflor universal mastic glue
- Finish: Brushed metal.

Specification

- Description: Protection plate (Plac'Inox as manufactured by Gerflor) in 10/10th mm brushed stainless steel approved for food handling areas. Its maximum length is 2.50 m and its maximum height 1.25 m.
- Finish: Brushed metal
- Installation method: glue as per manufacturer's instructions.

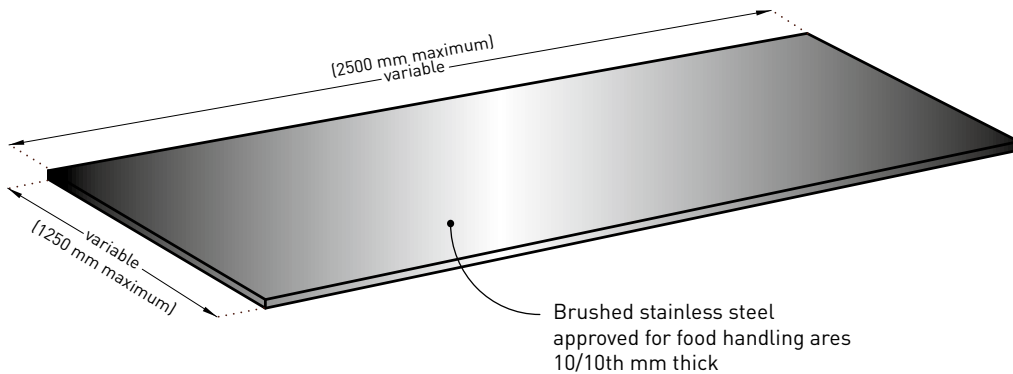





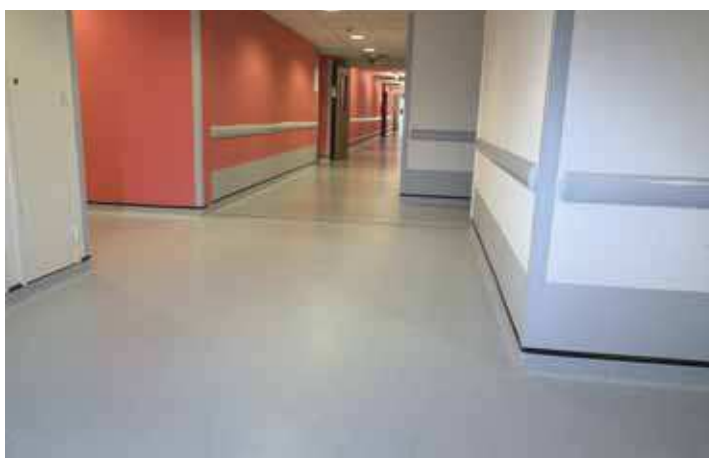



SPM CORNER PROTECTION



Corners are particularly prone to damage so they need to be well protected. Gerflor has developed a complete range of carefully designed corner protectors which combat wear and provide effective, safe protection. The corner protectors are either adhesive, for corners exposed to light impact, or on aluminium core, for corners in areas with intense activity, whether 90° or not. All have the same properties: they resist impact and the effects of cleaning and disinfectant products, and have a Bs2d0 fire rating.

	Code	Description	Material	Colour range
CAPCORN	 90° round corner protector on core	PVC + aluminium	5 colours	
CORNEA	 90° corner protector with strip on core	PVC + aluminium	31 colours	
CORNEAFLEX	 135° and variable angle corner protectors with strip on core	PVC + aluminium	5 colours	
PROFIL'INOX	 90° adhesive corner protectors	Stainless steel	Brushed finish	
LINEA'FLEX	 80° to 150° adhesive corner protector with variable angle endcap	PVC	32 colours	
PROTECTA 2	 70 to 135° adhesive corner protector with strip	PVC	32 colours	
PROFILA	 90° adhesive finishing corner protectors	PVC	32 colours	



CAPCORN p.56
90° round corner protector on core



PROFIL'INOX p.59
Adhesive 90° corner protectors in brushed stainless steel



CORNEA p.57
90° corner protector with strip on core



LINEA'FLEX p.60-61
Flexible adhesive corner protector with variable angle endcap



CORNEAFLEX p.58
135° and variable angle corner protectors with strip on core



PROTECTA 2 p.62
Variable angle adhesive corner protector



PROFILA p.63
90° adhesive corner protectors





Capcorn
5 colours*



*and 26 colours on request with a minimum order quantity

CAPCORN



▶ 90° ROUND CORNER PROTECTOR ON ALUMINIUM CORE

Applications

Combining elegance and strength, this round corner protector is ideally suited for protecting and decorating 90° corners. Recommended for use in corridors and areas exposed to heavy, frequent impact in hotels, restaurants, schools, offices, shops, hospitals, clinics, retirement homes.

Description

- Model: Capcorn round corner protector on aluminium core
- Angle: 90°
- Wing width: 45 mm (internal measurement)
- Thickness: 2.5 mm
- Length: 1.30 m, 2.00 m or 4.00 m
- Material: antibacterial and Bs2d0 fire-rated PVC, solid colour
- Surface finish: smooth
- Fixing system: continuous pre-drilled aluminium core
- Colours: 5 standard

Specification

- Description: 90° round corner protector mounted on aluminium core (Capcorn as manufactured by Gerflor) comprising 2.5 mm thick smooth and antibacterial PVC profile achieving Bs2d0 fire rating with solid colour. A protective film is specified to minimise cleaning before acceptance. Wings are 45 mm wide (internal measurement) and snap-fix to a continuous pre-drilled aluminium core. The corner protector is finished with a smooth PVC endcap.
- Environment: No heavy metals and no substance potentially subjected to any REACH restriction are used in its manufacture, nor PBT/BPA. The calcium-zinc thermal stabilisation process is used. The emission level of volatile substance in inside air has been tested according to ISO 16000-6 and is very low (A+) according to the French regulation (23 March 2011 nr 2011-321 Decree and 19 April 2011 Order). 100% of the product are recyclable.
- Colour: selected by architects from manufacturer's standard range.
- Installation method: snap-fixes to continuous pre-drilled aluminium core screwed to wall.

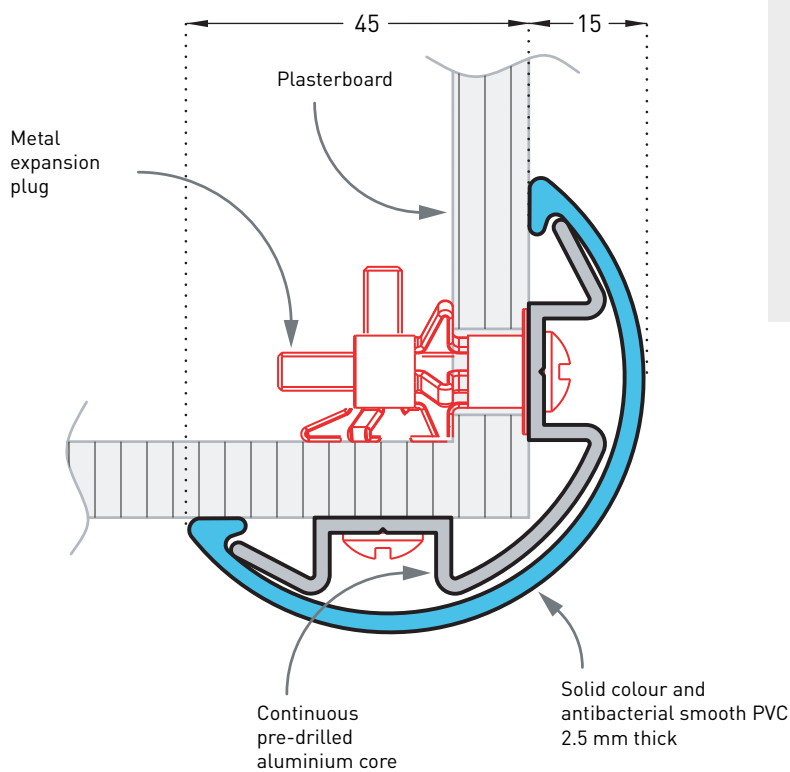

Specification and technical drawings can be downloaded from our website www.gerflor.com

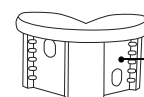

Smooth PVC endcap

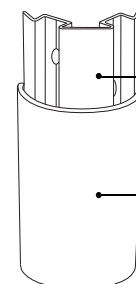

Continuous pre-drilled aluminium core

Smooth PVC profile



Cornea
31 colours



CORNEA



▶ 90° CORNER PROTECTOR ON ALUMINIUM CORE

Applications

Efficient protection for 90° angles exposed to heavy impact from trolleys and carts. A unique rounded spine makes corners harmless. Recommended for corridors and entrances to hospitals, clinics, laboratories, kitchens, schools, supermarkets.

Description

- Model: Cornea corner protector with contrast strip on aluminium core
- Angle: 90°
- Wing width: 60 mm (internal measurement)
- Thickness: 2.5 mm
- Length: 1.30 m, 2.00 m or 4.00 m
- Material: Antibacterial and Bs2d0 fire-rated PVC, solid colour
- Surface finish: smooth
- Fixing system: continuous pre-drilled aluminium core
- Colours: one-colour: 31 standard

Specification

- Description: 90° corner protector with contrast strip on aluminium core (Cornea as manufactured by Gerflor) comprising smooth and antibacterial 2.5 mm thick PVC profile achieving Bs2d0 fire rating with solid colour. A protective film is specified to minimise cleaning before acceptance. Wings are 60 mm wide (internal measurement) and snap-fix to continuous pre-drilled aluminium core. The central rounded bead forms a decorative and harmless contrast strip. Smooth PVC endcaps are provided for ends.
- Environment: No heavy metals and no substance potentially subjected to any REACH restriction are used in its manufacture, nor PBT/BPA. The calcium-zinc thermal stabilisation process is used. The emission level of volatile substance in inside air has been tested according to ISO 16000-6 and is very low (A+) according to the French regulation (23 March 2011 nr 2011-321 Decree and 19 April 2011 Order). 100% of the product are recyclable.
- Colour: selected by architects from manufacturer's standard range.
- Installation method: snap-fixes to continuous pre-drilled aluminium core screwed to wall.

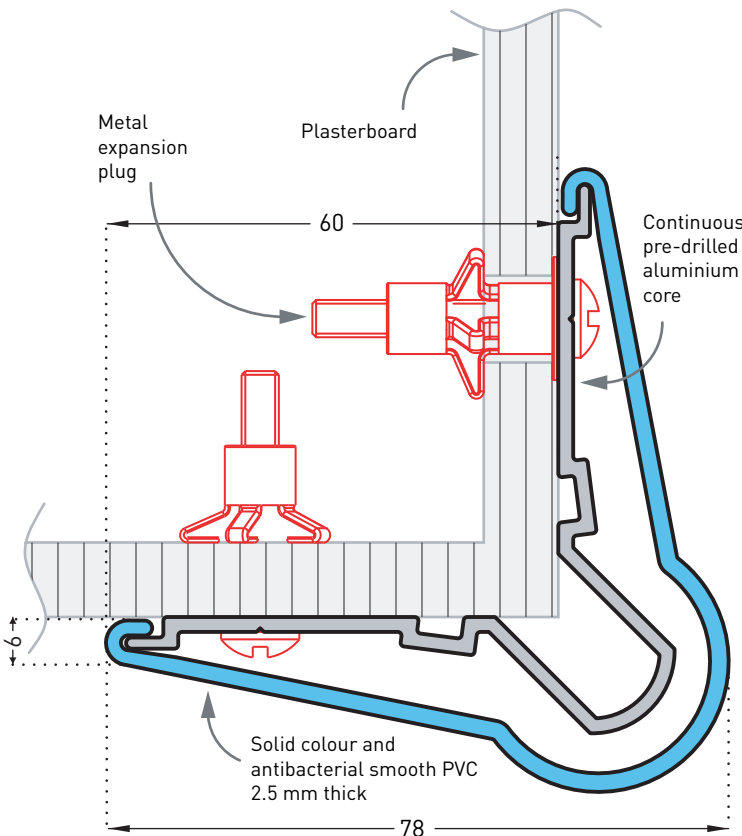

Specification and technical drawings can be downloaded from our website www.gerflor.com

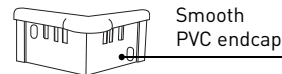

Smooth PVC endcap

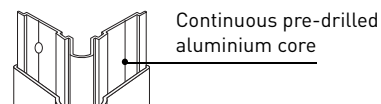

Continuous pre-drilled aluminium core

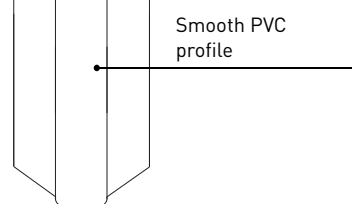

Smooth PVC profile



Corneaflex
5 colours*



*and 26 colours on request with a minimum order quantity

CORNEAFLEX



▶ 135° AND VARIABLE ANGLE CORNER PROTECTOR ON ALUMINIUM CORE

Applications

High-performance protection for corners: 135° or variable angles. Designed with an impact-resistant flexible spine and supple PVC reinforcement beads, this product makes corners safe and protects them against heavy traffic. For use in corridors and entrances to kitchens, laboratories, hospitals, clinics and schools.

Description

- Model: Corneaflex corner protector with flexible contrast strip on aluminium core
- Angle: 135° or variable angles
- Wing width: 65 mm (internal measurement)
- Length: 1.30 m, 2.00 m or 4.00 m (135°), 4.00 m (variable angle)
- Material: Antibacterial and solid colour, 2.5 mm thick rigid PVC wings achieving Bs2d0 fire rating and a 3.5 mm thick flexible contrast strip
- Surface finish: smooth
- Fixing system: continuous pre-drilled aluminium core for 135° angle. The core is in two parts for variable angles
- Colours: 5 standard

Specification

- Description: corner protector with flexible contrast strip on aluminium core (Corneaflex as manufactured by Gerflor) comprising smooth and antibacterial PVC profile achieving Bs2d0 fire rating with solid colour. A protective film is specified to minimise cleaning before acceptance. PVC profile snap-fixes to a continuous pre-drilled aluminium core. Wings are 2.5 mm to 3.5 mm thick, 65 mm wide (internal measurement) and open at 135° angle, or variable angles. Rounded flexible central contrast strip forms a decorative, highly effective cushion thanks to two internal flexible PVC reinforcement beads. Smooth PVC end caps are provided for 135° model.
- Environment: No heavy metals and no substance potentially subjected to any REACH restriction are used in its manufacture, nor PBT/BPA. The calcium-zinc thermal stabilisation process is used. The emission level of volatile substance in inside air has been tested according to ISO 16000-6 and is very low (A+) according to the French regulation (23 March 2011 nr 2011-321 Decree and 19 April 2011 Order). 100% of the product are recyclable.
- Colour: selected by architects from manufacturer's standard range.
- Installation method: snap-fixes to aluminium core screwed to wall.

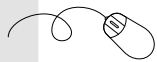

Specification can be downloaded from our website www.gerflor.com

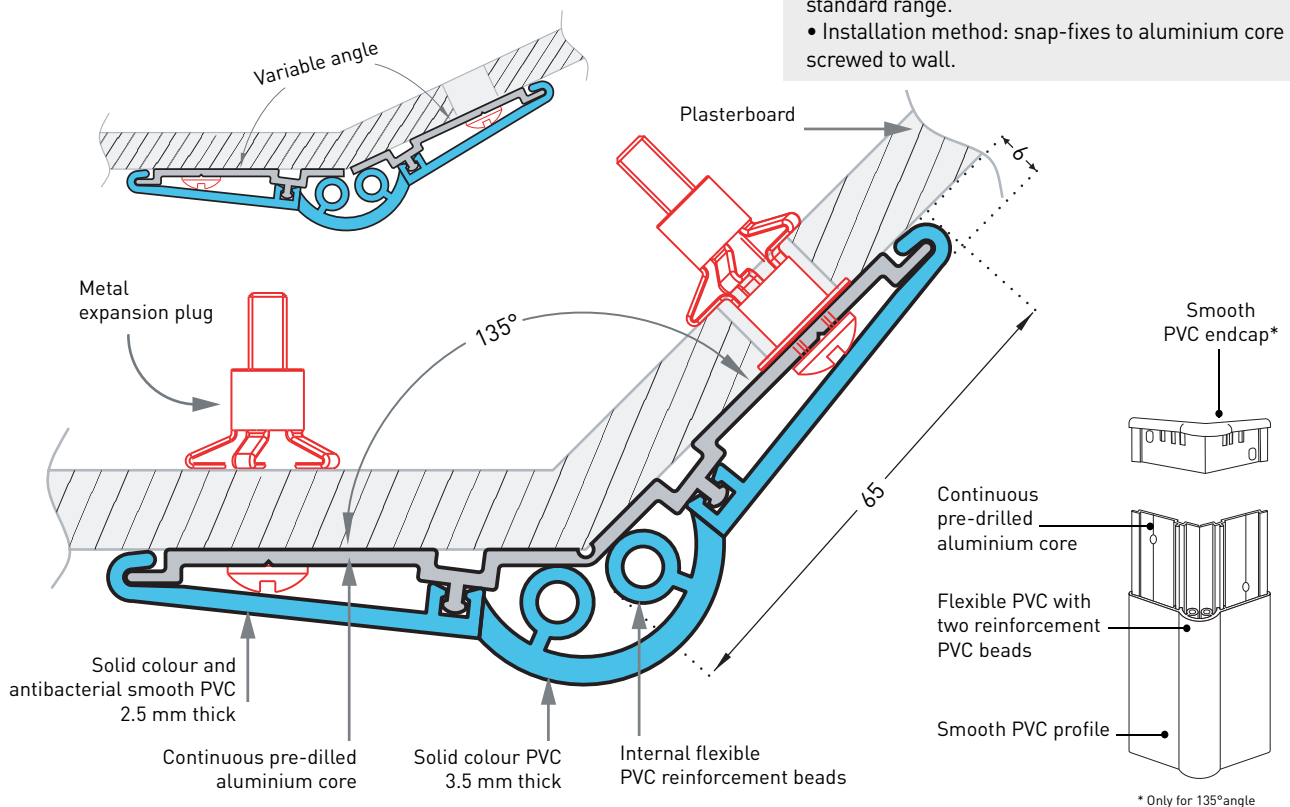



Profil'Inox
Brushed finish



PROFIL'INOX 50 AND 30



▶ 90° ADHESIVE CORNER PROTECTORS IN BRUSHED STAINLESS STEEL

Applications

Profil'Inox protect 90° corners exposed to impacts. They are instantly recognisable by their rounded spine and lightly chamfered sides. They are approved for use in food-handling areas. Ideally suited for heavily used or damp areas, they are particularly useful in the food and pharmaceutical industries as well as in healthcare establishments, main kitchens, etc.

Description

- Model: Profil'Inox 50 or 30
- Adhesive corner protector
- Angle: 90°
- Wing width: 50 or 30 mm
- Thickness: 10/10th mm
- Length: 2.50 m
- Material: Stainless steel (approved for food-handling areas)
- Fixing: Adhesive foam strips reinforced with Gerflor universal mastic glue
- Finish: Brushed metal

Specification

- Description: 90° adhesive corner protector with 50 mm wings (such as Gerflor's Profil'Inox 50), or with 30 mm wings (such as Gerflor's Profil'Inox 30), in 10/10th brushed stainless steel approved for food handling areas and provided with two adhesive foam tapes. Wings are lightly beveled. A protective film is specified to minimise cleaning before acceptance.
- Finish: Brushed metal
- Installation method: Adhesive. Gerflor universal mastic glue is recommended for stronger fixing.



Specification can be downloaded from our website www.gerflor.com

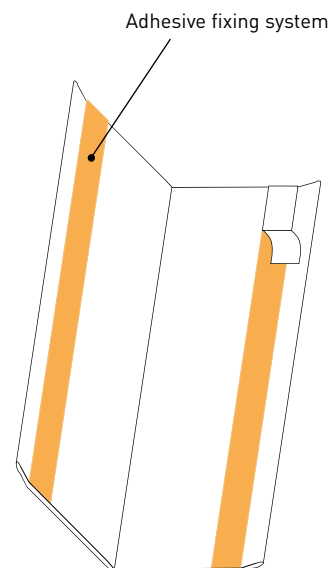
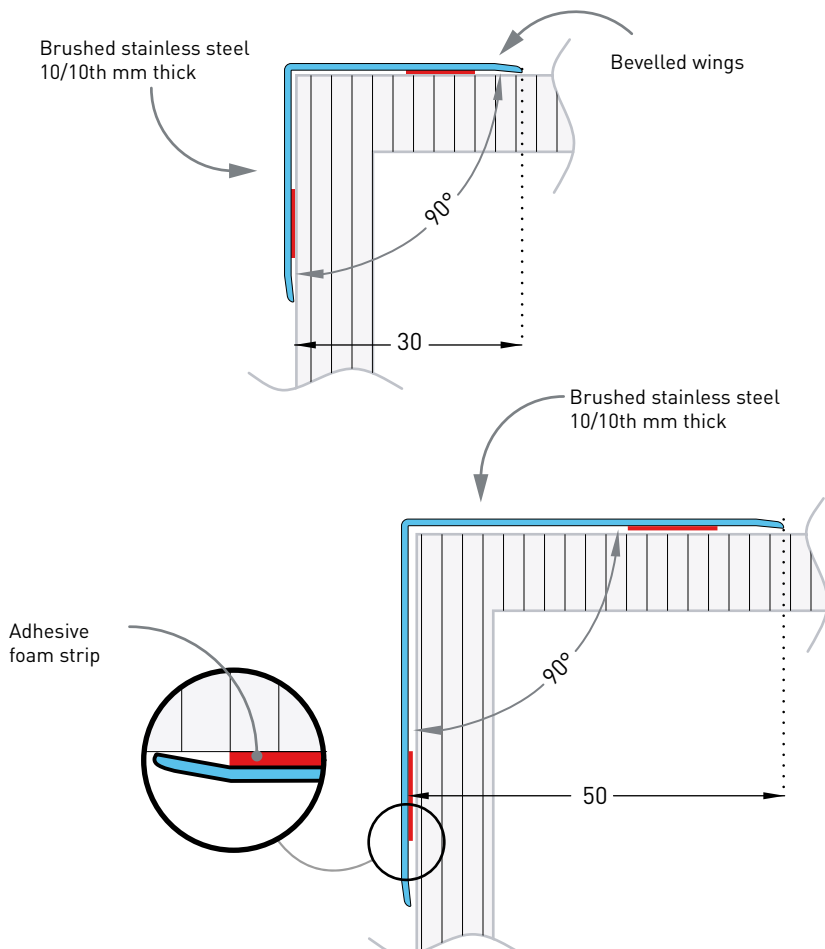



LINEA'FLEX



▶ FLEXIBLE ADHESIVE CORNER PROTECTOR WITH VARIABLE ANGLE ENDCAP

Applications

The Linea'Flex corner protector is the product of advanced technical expertise, combining impact resistance, flexibility and discretion, and blending perfectly with the Linea range. It provides effective protection for all angles from 80° to 150° thanks to its flexible central part mounted on two dampers for added resistance. Thanks to its variable angle endcap it fits to any height with maximum hygiene. Installation is quick and easy with two strips of double-sided adhesive tape. It blends discreetly into corridors and rooms that are exposed to repeated impacts in hospitals, clinics, retirement homes, schools, hotels, restaurants, offices and stores.

Description

- Model: Linea'Flex flexible adhesive corner protector with variable angle endcap
- Angle: from 80° to 150°
- Wing width: 53 mm
- Thickness: cross-section up to 3 mm
- Length: 1.30 m, 2.00 m or 4.00 m
- Material: antibacterial and Bs2d0 fire-rated PVC, solid colour
- Surface finish: smooth
- Fixing: adhesive foam strips reinforced with Gerflor universal mastic glue
- Colours: 32 standard

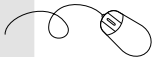

Specification and technical drawings can be downloaded from our website www.gerflor.com

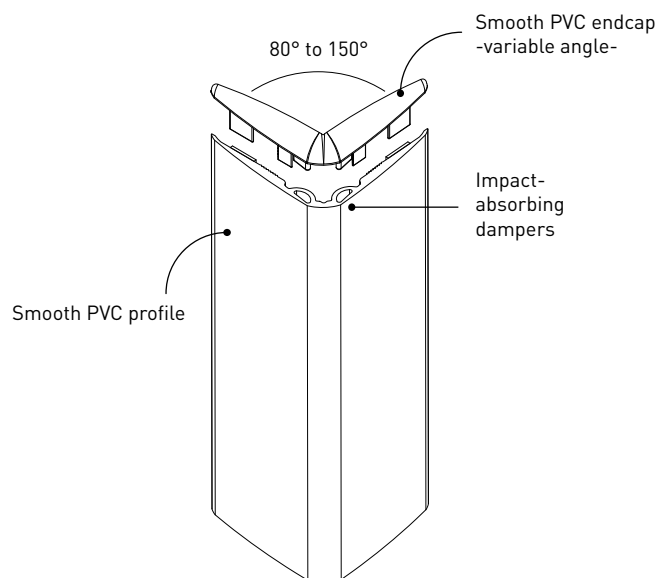

Linea'Flex 32 colours

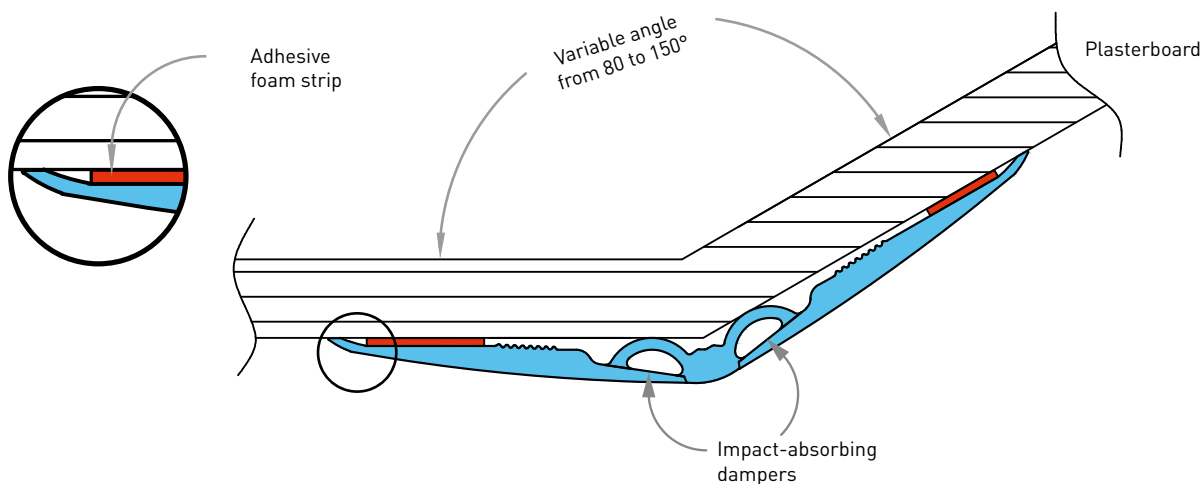
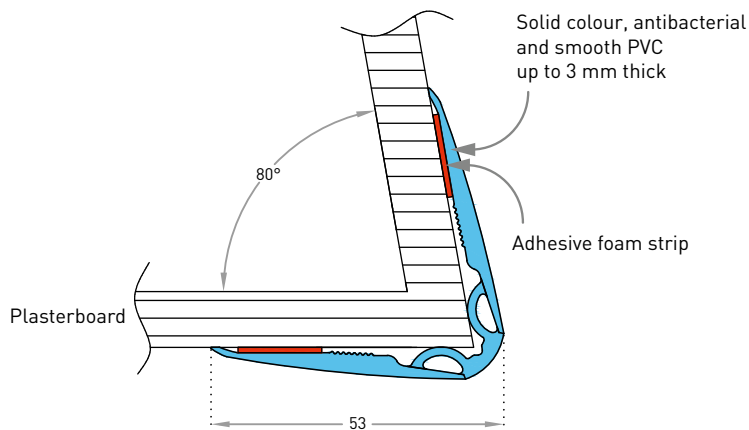

Specification

- **Description:** The selected corner protector (Linea'Flex as manufactured by Gerflor) is a flexible, adhesive corner protector with a variable angle endcap (from 80 to 150°) and 53 mm wide wing. Its smooth and antibacterial PVC profile is 1 to 3 mm thick with solid colour. The central part is reinforced with two impact-absorbing dampers. The wrenching grip is minimal by the progressive thickness and the bevelled shape of the profile. The corner protector's finish is provided by a flexible and bevelled PVC endcap. It comes with two, factory-fitted, double-sided adhesive foam strips. A protective film is specified to minimise cleaning before acceptance. This corner protector achieves Bs2d0 fire-rating and an impact resistance in excess of 110 Joules, i.e., an impact of more than 320 kg travelling at 3 kmh.

- **Environment:** No heavy metals and no substance potentially subjected to any REACH restriction are used in its manufacture, nor PBT/BPA. The calcium-zinc thermal stabilisation process is used. The emission level of volatile substance in inside air has been tested according to ISO 16000-6 and is very low (A+) according to the French regulation [23 March 2011 nr 2011-321 Decree and 19 April 2011 Order]. 100% of the product are recyclable.
- **Colour:** selected by architects from manufacturer's standard range. The endcap colours are the same as the profile of the corner protector.
- **Installation method:** Installation is easy and quick using the double-sided adhesive foam strips. We recommend enhancing this with the use of a solvent-free universal mastic glue, such as Gerflor's AC004.



Protecta 2
32 colours



PROTECTA 2



▶ VARIABLE ANGLE ADHESIVE CORNER PROTECTOR

Applications

Thanks to its rounded, reinforced spine, this product provides efficient, decorative and economical protection for all corners exposed to frequent impact. Available in 32 standard colours, this model blends in with all interior decoration styles in public buildings.

Description

- Model: Protecta 2 adhesive corner protector
- Angle: from 70 to 135°
- Wing width: 60 mm
- Thickness: 2 mm
- Length: 1.30 m, 2.00 m or 4.00 m
- Material: Antibacterial and Bs2d0 fire-rated PVC, solid colour
- Surface finish: Smooth
- Fixing: Adhesive foam strips reinforced with Gerflor universal mastic glue
- Colours: 32 standard

Specification

- Description: 60 mm wide wing (internal measurement), variable angle corner protector (from 70° to 135°) with flexible contrast strip (Protecta 2 as manufactured by Gerflor) comprising smooth and antibacterial PVC profile achieving Bs2d0 fire rating with solid colour. A protective film is specified to minimise cleaning before acceptance. 2 mm thick wing. Central rounded bead forms a decorative and harmless contrast strip. It is provided with 2 strips of foam adhesive tape for fixing.
- Environment: No heavy metals and no substance potentially subjected to any REACH restriction are used in its manufacture, nor PBT/BPA. The calcium-zinc thermal stabilisation process is used. The emission level of volatile substance in inside air has been tested according to ISO 16000-6 and is very low (A+) according to the French regulation (23 March 2011 nr 2011-321 Decree and 19 April 2011 Order). 100% of the product are recyclable.
- Colour: selected by architects from manufacturer's standard range.
- Installation method: Adhesive. Gerflor universal mastic glue is recommended for stronger fixing.

Specification and technical drawings can be downloaded from our website www.gerflor.com

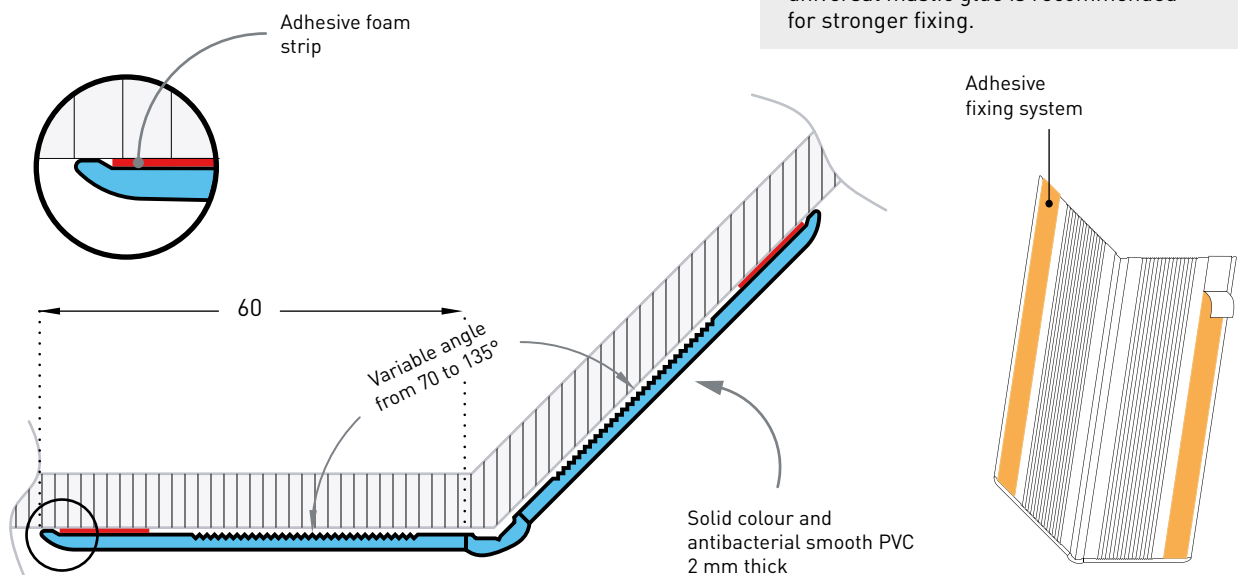
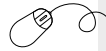

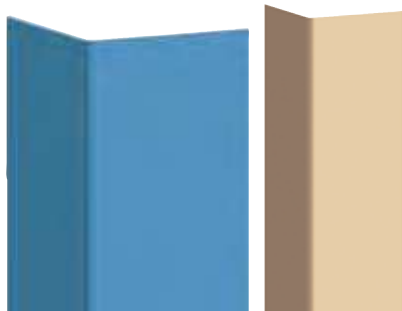

Profila 30 / Profila 50
32 colours



PROFILA 50 AND 30



▶ 90° ADHESIVE CORNER PROTECTOR

Applications

These corners protectors blend in seamlessly with all interiors and protects corners from light impacts. Profila 30 can also protect some door frames.

Description

- Model: Profila 50 and 30 adhesive corner protectors
- Angle: 90°
- Wing width:
50 mm Profila 50
30 mm Profila 30
- Thickness: 2 mm
- Length: 1.30 m, 2.00 m or 4.00 m
- Material: Antibacterial and Bs2d0 fire-rated PVC, solid colour
- Surface finish: Smooth
- Fixing: Adhesive foam strips reinforced with Gerflor universal mastic glue
- Colours: 32 standard

Specification

- Description: 50 mm or 30 mm wide wings, 90° corner protector (Profila 50 or 30 as manufactured by Gerflor) comprising smooth and antibacterial PVC profile achieving Bs2d0 fire rating with solid colour. A protective film is specified to minimise cleaning before acceptance. 2 mm thick, wings are 50 mm or 30 mm wide (internal measurement). It is provided with 2 strips of foam adhesive tape for fixing.
- Environment: No heavy metals and no substance potentially subjected to any REACH restriction are used in its manufacture, nor PBT/BPA. The calcium-zinc thermal stabilisation process is used. The emission level of volatile substance in inside air has been tested according to ISO 16000-6 and is very low (A+) according to the French regulation (23 March 2011 nr 2011-321 Decree and 19 April 2011 Order). 100% of the product are recyclable.
- Colour: selected by architects from manufacturer's standard range.
- Installation method: Adhesive. Gerflor universal mastic glue is recommended for stronger fixing.

Specification and technical drawings can be downloaded from our website www.gerflor.com

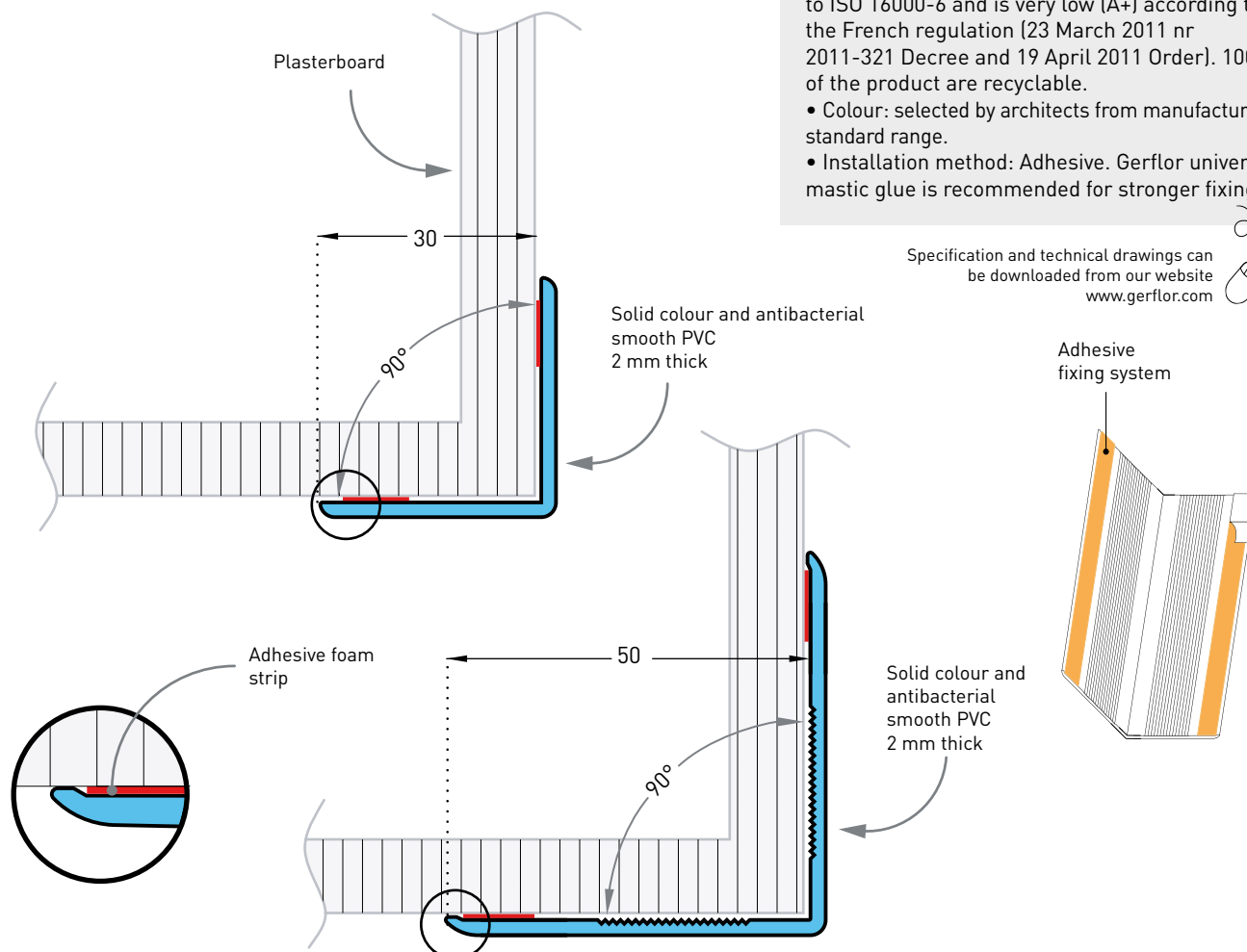



SPM DOOR PROTECTION



EHPAD Ayzac Ost (65)



Maison de retraite de Montréjeau (31)

In medical and other public body establishments, doors are subjected to the harshest of tests: the facing and side edges are particularly exposed and prone to damage, and are knocked by trolleys, stretchers and other mobile equipment.

Gerflor has developed a range of protection panels and protective hand plates.

They can be cut to size, folded into L or U bends, and can be adapted to fit all types of woodwork.

It is essential to protect and you can also add a decorative touch with some of Gerflor's original designs.

	Code	Description	Material	Colour range
FOOT-HEIGHT DOOR		Contact 350 or 200 plates	PVC	15 or 31 colours
HALF-HEIGHT DOOR		Straight cut Decochoc panel	PVC	32 colours
		Straight cut Decosmic panel	PVC	3 colours
		Plac'Inox protection plate	Stainless steel	Brushed finish
HALF-HEIGHT DECORATIVE DOOR		Decochoc panel with decorative cut outs	PVC	32 colours to combine
		Decosmic panel with decorative cut outs	PVC	3 colours to combine
HANDPLATES		Decochoc panel with decorative cut outs	PVC	32 colours
		Decosmic panel with decorative cut outs	PVC	3 colours
INLAYED SIGNAGE		Decochoc panel 1/2 height door	PVC	32 colours for numerals and pictos 11 drawings Early childhood
		Decosmic panel 1/2 height door	PVC	3 colours for numerals and pictos
EDGES AND FRAMES		Decochoc panel bends and thermoforming	PVC	32 colours
		Decosmic panel bends and thermoforming	PVC	3 colours



FOOT-HEIGHT DOOR

p.66

Contact plates
Plac'Inox



HANDPLATES

p.70

Decochoc panel
Decosmic panel
- decorative cutouts -



HALF-HEIGHT DOOR

p.67

Decochoc panel
Decosmic panel
Plac'Inox
- straight cut -



**HALF-HEIGHT DOOR
INLAID SIGNAGE**

p.71

Numerals, pictos
and early childhood



**HALF-HEIGHT
DECORATIVE DOOR**

p.68-69

Decochoc panel
Decosmic panel
(one or two-colour)
- decorative cutouts -



EDGES AND FRAMES

p.72-73

Decochoc panel
Decosmic panel
- bends and thermoforming -





Contact 350 15 colours *



*and 16 colours on request with a minimum order quantity

Contact 200 31 colours



FOOT-HEIGHT DOOR



CONTACT PROTECTION PLATES

Recommended protection height: 200 mm or 350 mm.

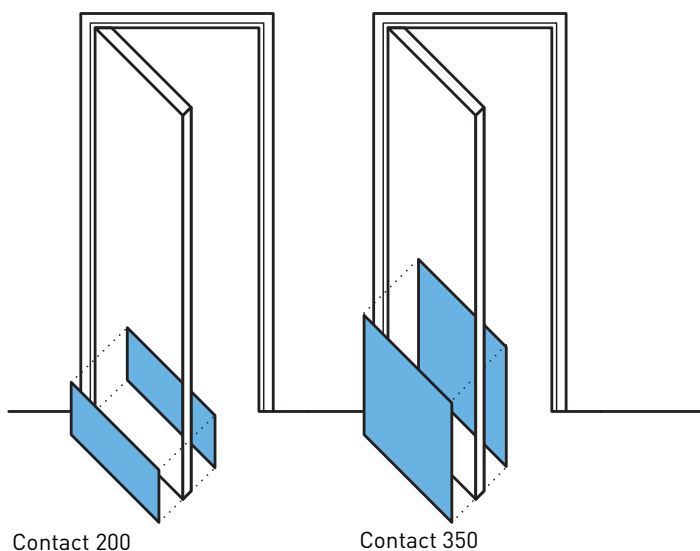

Description

- Model: Contact 350 and 200 adhesive protection plates
- Section depth: 350 or 200 mm
- Thickness: 2.5 mm
- Length: 4 m
- Material: Antibacterial and Bs2d0 fire-rated PVC, solid colour
- Surface finish: Smooth with decorative grooves
- Fixing: Adhesive foam strips reinforced with Gerflor universal mastic glue
- Colours: 31 standard for Contact 200 and 15 for Contact 350.

Specification

- Description: Adhesive protection plates (Contact 350 or 200 as manufactured by Gerflor) from smooth and antibacterial PVC with a depth of 350 or 200 mm, 2.5 mm thick. PVC profiles achieving Bs2d0 fire rating, feature solid colour and smooth surface finish with decorative grooves. A protective film is specified to minimise cleaning before acceptance. Sections are delivered with 2 or 3 strips of adhesive foam for fixing.
- Environment: No heavy metals and no substance potentially subjected to any REACH restriction are used

in its manufacture, nor PBT/BPA. The calcium-zinc thermal stabilisation process is used. The emission level of volatile substance in inside air has been tested according to ISO 16000-6 and is very low (A+) according to the French regulation (23 March 2011 nr 2011-321 Decree and 19 April 2011 Order). 100% of the product are recyclable.

- Colour: Selected by architects from manufacturer's standard range.
- Installation method: Adhesive. Gerflor universal mastic glue is recommended for stronger fixing.



Specification and drawings can be downloaded from our website www.gerflor.com

PLAC'INOX STAINLESS STEEL PROTECTION PLATE

Please refer to page 53.



HALF-HEIGHT DOOR



▶ DECOCHOC / DECOSMIC PROTECTION AND COVERING PANELS - STRAIGHT CUT -

Recommended protection height: from 800 mm to 1300 mm.

Applications

Protects and decorates doors in corridors and entrances to hospitals, clinics, retirement homes, schools, kitchens, restaurants, collective housing...
To avoid the handle and lock and facilitate installation, we recommend a protection height below either 900 mm or 1100 mm.

Description

- Model: Cut-to-size Decochoc or Decosmic protection and covering panel
- Standard panel dimensions: 3 m x 1,30 m
- Custom options: Bendings, thermoformings, chamfers
- Thickness: 2 mm
- Material: Antibacterial and Bs2d0 fire-rated PVC, solid colour
- Surface finish: Lightly textured
- Fixing: Adhesive bonding with Gerflor acrylic glue or Gerflor universal mastic glue
- Colours: 32 standard for Decochoc and 3 for Decosmic.

Specification

- Description: Protection and covering panel (Decochoc or Decosmic as manufactured by Gerflor) from antibacterial PVC achieving Bs2d0 fire rating with solid colours. Surface is lightly textured, 2 mm thick. A protective film is specified to minimise cleaning before acceptance.
- Environment: No heavy metals and no substance potentially subjected to any REACH restriction are used in its manufacture, nor PBT/BPA. The calcium-zinc thermal stabilisation process is used. The emission level of volatile substance in inside air has been tested according to ISO 16000-6 and is under 15µg/m³. 100% of the product are recyclable.
- Colour: Selected by architects from manufacturer's standard range.
- Installation method: glue as per manufacturer's instructions.

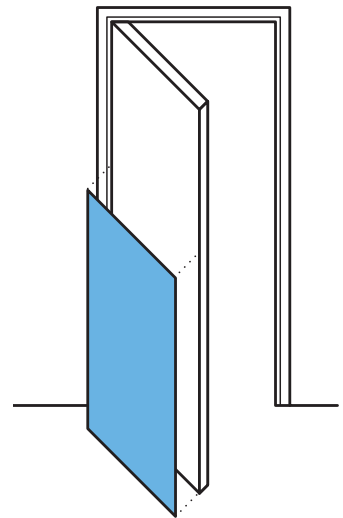

Specification can be downloaded from our website www.gerflor.com

Door protection

▶ PLAC'INOX STAINLESS STEEL PROTECTION PLATE

Please refer to page 53.



HALF-HEIGHT DECORATIVE DOOR



▶ DECOCHOC / DECOSMIC PROTECTION AND COVERING PANELS - DECORATIVE CUTOUTS -

One colour

Applications

These cutouts provide half-height protection and decoration for doors. Ideal for use in corridors in public buildings: hospitals, restaurants, hotels...

Shapes and colours make easier the location of different doors: rooms, staff rooms, technical premises, etc.

Description

- Description: 4 one-colour standard protection and covering masks
- Cut-to-size Decochoc or Decosmic panel.
- Thickness: 2 mm
- Material: Antibacterial and Bs2d0 fire-rated PVC, solid colour.
- Surface finish: lightly textured
- Fixing: adhesive bonding with Gerflor acrylic glue or Gerflor universal mastic glue
- Colours: 32 standard for Decochoc and 3 for Decosmic

Specification

- Description: half-height decorative one colour door protection (Iron, Wave, Mountain or Cubic masks as manufactured by Gerflor) from antibacterial PVC achieving Bs2d0 fire rating with solid colour. Lightly textured surface finish, 2 mm thick. A protective film is specified to minimise cleaning before acceptance.
- Environment: No heavy metals and no substance potentially subjected to any REACH restriction are used in its manufacture, nor PBT/BPA. The calcium-zinc thermal stabilisation process is used. The emission level of volatile substance in inside air has been tested according to ISO 16000-6 and is under 15µg/m³. 100% of the product are recyclable.
- Colour: selected by architects from manufacturer's standard range.
- Installation method: glue as per manufacturer's instructions.



Specification can be downloaded from our website www.gerflor.com

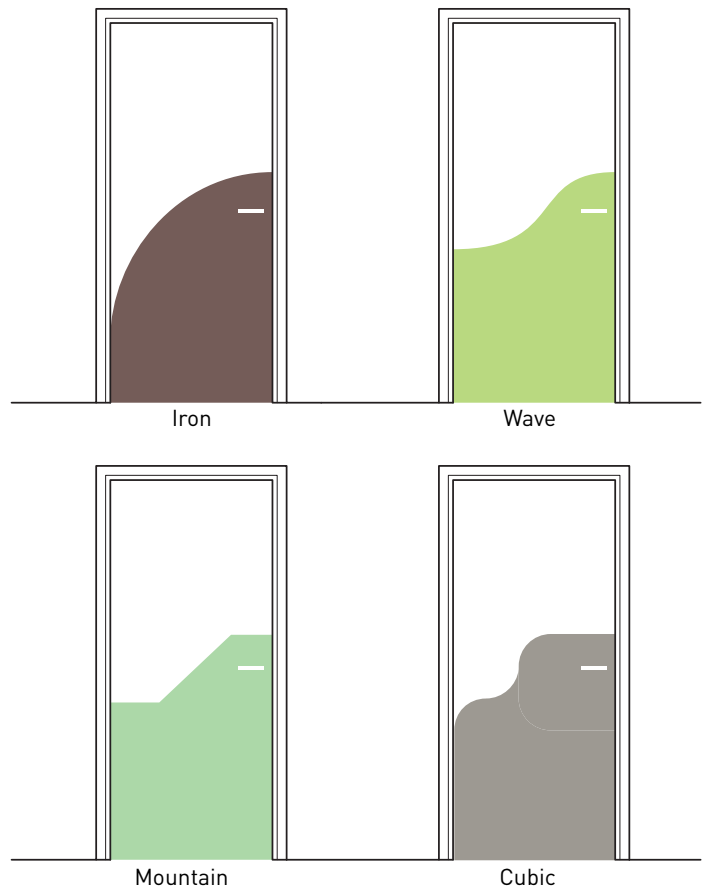

Decochoc
32 colours



Two-colour

Applications

These half-door claddings protect and bring a touch of originality. This two-colour range provides visual help by using floor, department, service or section colour schemes, very useful in accessibility process.

Description

- Model: 5 two-colour standard protection and covering masks
- Cut-to-size Decochoc or Decosmic panel.
- Height: 1200 mm
- Width: 930 or 1230 mm
- Thickness: 2 mm
- Material: Antibacterial and Bs2d0 fire-rated PVC, solid colour.
- Surface finish: lightly textured
- Fixing: adhesive bonding with Gerflor acrylic glue or Gerflor universal mastic glue
- Colours: 32 standard for Decochoc and 3 for Decosmic

Specification

- Description: half-height decorative two-colour door protection (Stratum, Cubic, Comma, Stairs, Rainbow masks as manufactured by Gerflor) from rigid and antibacterial PVC achieving Bs2d0 fire rating with solid colour and textured surface. 2 mm thick. The width is 930 or 1230 mm, height 1200 mm.
- Environment: No heavy metals and no substance potentially subjected to any REACH restriction are used in its manufacture, nor PBT/BPA. The calcium-zinc thermal stabilisation process is used. The emission level of volatile substance in inside air has been tested according to ISO 16000-6 and is under 15µg/m³. 100% of the product are recyclable.
- Colour: selected by architect from manufacturer's standard range
- Installation method: glue as per manufacturer's instructions.

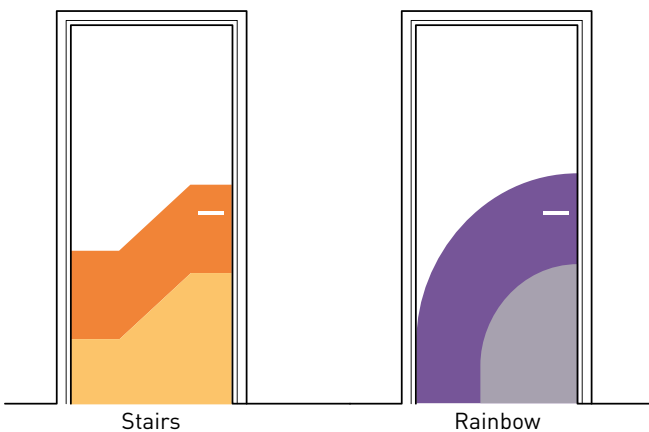
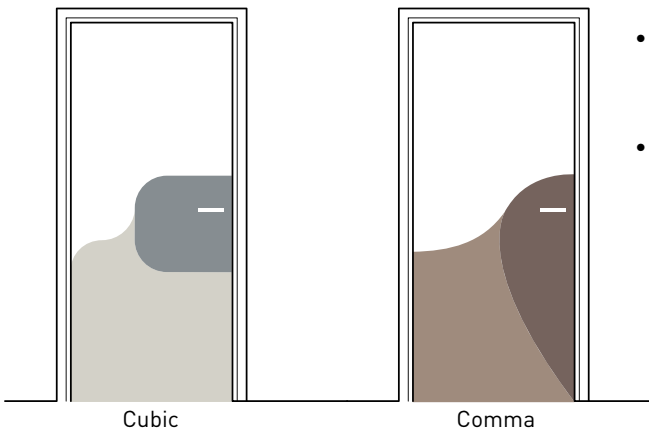
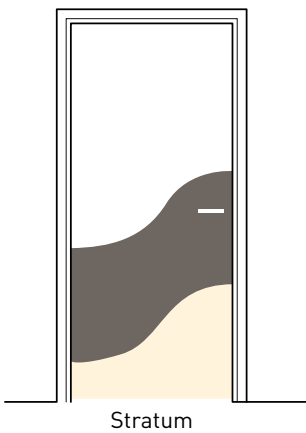



Decochoc
32 colours



HANDPLATES



▶ DECOCHOC / DECOSMIC PROTECTION AND COVERING PANELS - DECORATIVE CUTOUTS -

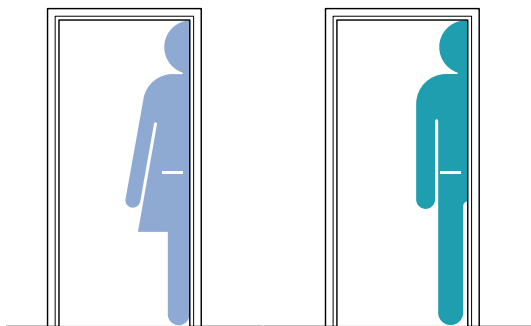

Lady

Man

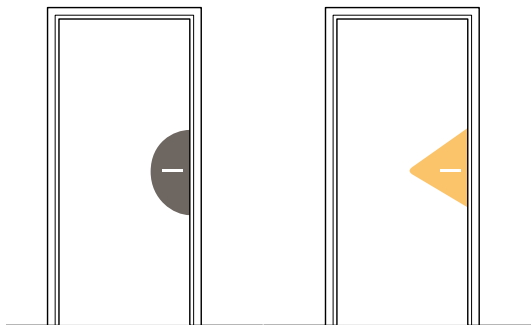

Plac'net

Delta

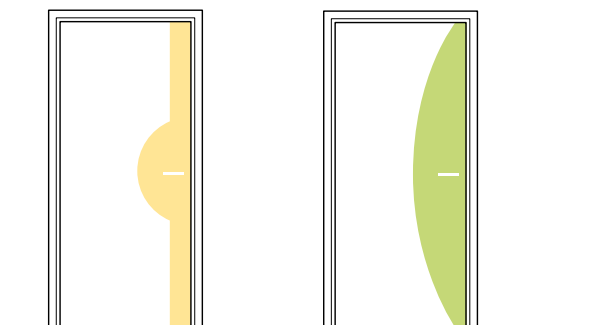

Nö

Glass

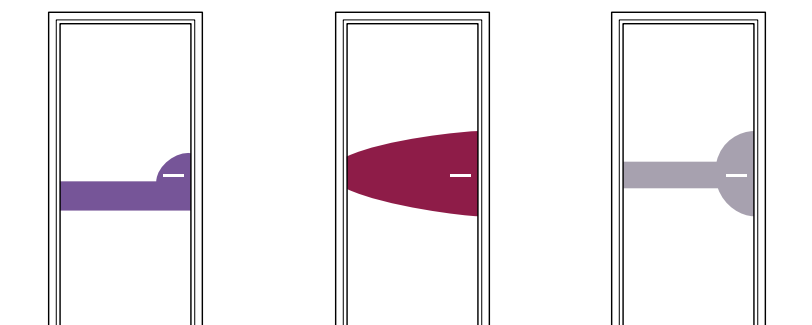

Eclipse

Wooden

Dan

Applications

These original shapes are used to decorate and protect doors from wear and dirt around handles. Perfect for all collective institutions: schools, hotels, offices, restaurants, hospitals, retirement homes...

Description

- Model: 9 standard masks of handplates
- Cut-to-size Decochoc or Decosmic panel
- Thickness: 2 mm
- Material: Antibacterial and Bs2d0 fire-rated PVC, solid colour
- Surface finish: Lightly textured
- Fixing: Adhesive or Gerflor acrylic glue or Gerflor universal mastic glue
- Colours: 32 standard for Decochoc and 3 for Decosmic

Specification

- Description: handplates (Nö, Glass, Lady, Man, Wooden, Dan, Eclipse, Plac'net or Delta masks as manufactured by Gerflor) from antibacterial PVC achieving Bs2d0 fire rating with solid colour. Lightly textured surface finish, 2 mm thick.
- Environment: No heavy metals and no substance potentially subjected to any REACH restriction are used in its manufacture, nor PBT/BPA. The calcium-zinc thermal stabilisation process is used. The emission level of volatile substance in inside air has been tested according to ISO 16000-6 and is under $15\mu\text{g}/\text{m}^3$. 100% of the product are recyclable.
- Colour: selected by architects from manufacturer's standard range.
- Installation method: adhesive or glue as per manufacturer's instructions.



Decochoc
Signage numbers
32 colours



Decosmic
3 colours

INLAID SIGNAGE



FOR DECOCHOC OR DECOSMIC PANEL HALF-HEIGHT DOOR PROTECTION

Applications

The inlaid signage with numerals, pictos or Early Childhood drawings individually identify your half-door protections in Decochoc or Decosmic by forming an effective and robust marking that is visible from a distance and easy to clean. The drawings will be highly appreciated by the young public in particular, who will be easily be able to find directions.

Description

- Model: Decochoc or Decosmic inlaid signage with numerals, pictos or Early Childhood drawings
- Height: 400 mm
- Thickness: 2 mm
- Material: Antibacterial and Bs2d0 fire-rated PVC, solid colour
- Surface finish: lightly textured
- Fixing: adhesive bonding with Gerflor acrylic glue or Gerflor universal mastic glue
- Colours:
 - for the numerals and pictos: 32 standard in Decochoc 3 standard in Decosmic
 - for the Early Childhood drawings: 11 standard drawings (defined colours)

Specification

- Description: Inlaid signage in half-door protection (Numerals, pictos or Early Childhood drawings as manufactured by Gerflor) from rigid and antibacterial PVC achieving Bs2d0 fire rating with solid colour and textured surface. 2 mm thick, 400 mm high.
- Environment: No heavy metals and no substance potentially subjected to any REACH restriction are used in its manufacture, nor PBT/BPA. The calcium-zinc thermal stabilisation process is used. The emission level of volatile substance in inside air has been tested according to ISO 16000-6 and is under 15µg/m³. 100% of the product are recyclable.
- Colour: selected by architects from manufacturer's standard range
- Installation method: glue as per manufacturer's instructions.

Specification can be downloaded from our website www.gerflor.com

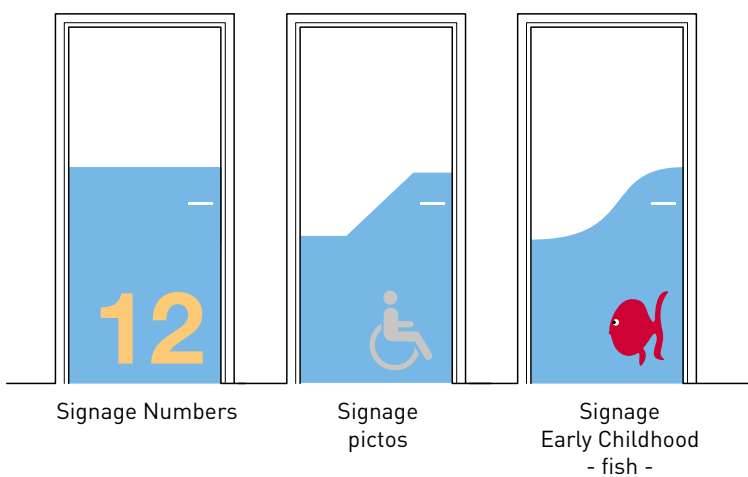

Signage pictos*

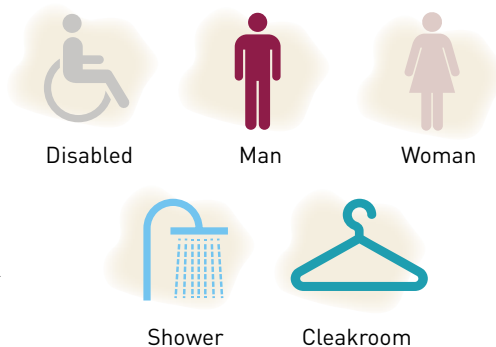

*Other pictos : consult us

Signage early childhood drawings



To find the colours available for each product, please see the summary table for the range at the end of this guide.



EDGES AND FRAMES



▶ DECOCHOC / DECOSMIC PANELS - BENDS INTO L AND U SHAPES -

Applications

Provides protection for door edges and simple frames edges against frequent impact from trolleys (corridors and entrances to healthcare facilities, laboratories...). Lateral edges are exposed to impacts from trolleys, beds... and below edges to water leaks in the door. U-bend is perfect for damp rooms such as bathrooms, sanitary arrangements, central kitchens...

Description

- Model: Cut-to-size protection and covering Decochoc or Decosmic panel with bends into L and U shapes*
- Thickness: 2 mm
- Material: Antibacterial and Bs2d0 fire-rated PVC, solid colour
- Surface finish: lightly textured
- Fixing: adhesive bonding with Gerflor acrylic glue or Gerflor universal mastic glue
- Colours: 32 standard for Decochoc and 3 for Decosmic

Specification

- Description: door protection and covering panel with bends into L or U for edge or frame protection (Decochoc or Decosmic as manufactured by Gerflor) from antibacterial PVC achieving Bs2d0 fire rating with solid colour. Lightly textured surface finish, 2 mm thick.
- Environment: No heavy metals and no substance potentially subjected to any REACH restriction are used in

its manufacture, nor PBT/ BPA. The calcium-zinc thermal stabilisation process is used. The emission level of volatile substance in inside air has been tested according to ISO 16000-6 and is under $15\mu\text{g}/\text{m}^3$. 100% of the product are recyclable.

- Colour: Selected by architects from manufacturer's standard range
- Installation method: Glue as per manufacturer's instructions.



Specification can be downloaded from our website www.gerflor.com

*For bend of other panels: consult us

Decochoc 32 colours

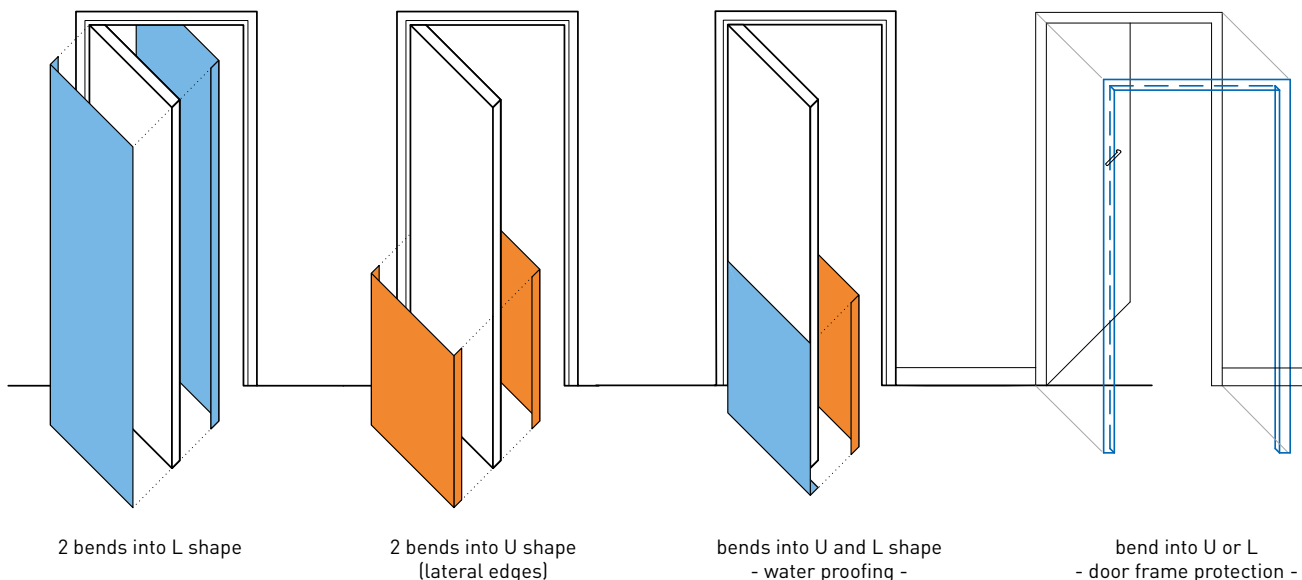

2 bends into L shape

2 bends into U shape
(lateral edges)

bends into U and L shape
- water proofing -

bend into U or L
- door frame protection -

▶ THERMOFORMING OF DECOCHOC AND DECOSMIC PANELS*

Applications

For complex door frames which cannot be protected by L or U bends (corridors in hospitals, clinics, nursing homes...) and for rounds pillars.

Description

- Model: Cut-to-size Decochoc or Decosmic protection and covering panels with thermoforming according to template provided*
- Thickness: 2 mm
- Material: Antibacterial and Bs2d0 fire-rated PVC, solid colour
- Surface finish: lightly textured
- Fixing: adhesive bonding with Gerflor acrylic glue or Gerflor universal mastic glue
- Colours: 32 standard for Decochoc and 3 for Decosmic

*For thermoforming of other panels: consult us

Specification

- Description: Cut to size and thermoformed protection and covering panel (Decochoc or Decosmic as manufactured by Gerflor) from antibacterial PVC achieving Bs2d0 fire rating with solid colour. Lightly textured surface finish, 2 mm thick.
- The level required for biocleaning should be validated for very high infectious risk areas such as operating theatres (sector 4) according to the Pasteur Institute of Lille (France). The chemical and mark resistance should have been proved on the usual cleaning products according to ISO 26987. The ease of nuclear decontamination according to ISO 8690 should be excellent.
- Environment: No heavy metals and no substance potentially subjected to any REACH restriction are used in its manufacture, nor PBT/BPA. The calcium-zinc thermal stabilisation process is used. The emission level of volatile substance in inside air has been tested according to ISO 16000-6 and is under $15\mu\text{g}/\text{m}^3$. 100% of the product are recyclable.
- Colour: selected by architects from manufacturer's standard range.
- Installation sequence: Glue as per manufacturer's instructions.

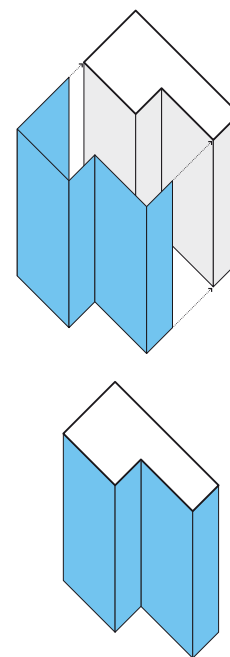

Thermoforming
Complex frame
protection



Specification can be downloaded from our website www.gerflor.com

SPM HANDRAILS



Polyclinique de Lormont [33] - BDM Architectes [33] - photo : Nadège PETRUCCI

Providing a good grip is a priority. SPM handrails have been designed with the greatest of care to aid mobility. Essentially, they are ergonomic, and provide both visual guidance (use of contrast provided by colours) and wall protection.

Our systems are available in antibacterial PVC or aluminium and can be adapted to fit any surface: walls where there is service ducts, curved walls, corners which are not 90°, staircases, while respecting the original decor.

SPM handrails protect against hand-borne infections

Inside establishments open to the public, and especially in health-care institutions, hygiene and the prevention of microbial contamination are permanent concerns. In particular, the hands form a significant vector for the carriage and transmission of contamination, which may be deposited on handrails. According to research, 75 to 90% of in-hospital infection in health-care establishments may be due to hand-borne transmission.

Rough edges on the handrail, at the junctions between profile sections and finisher accessories, collect the majority of contamination and are the most difficult points to clean.

For this reason, all SPM handrails are fitted with bactericidal joints, treated integrally and undamaged by cleaning. Their bactericidal action, proved by an independent laboratory, complements the bacteriostatic and antibacterial properties of our handrails, all of which have a smooth finish.

SPM handrails provide effective help in the fight against the growth of microorganisms and the spread of infection.

	Code	Description	Material	Colour range
PERFORMER 2		Protection handrail	PVC + aluminium	15 colours
STARLINE - PVC SHEATHED		Protection handrail with PVC band	PVC-sheathed aluminium + PVC band	32 colours for the band 2 colours for the sheath
STARLINE - ANODISED		Aluminium handrail with PVC band	Aluminium + PVC band	32 colours for the band
STARLINE DECOWOOD OR DECOTREND		Aluminium handrail with wood or trend effect band	Aluminium + wood or trend effect band	7 wood effect colours and 4 trend effect colours for the band
LINEA TOUCH - PVC SHEATHED		Trilobed handrail, width 40 mm	PVC + aluminium	31 colours
LINEA TOUCH - DECOWOOD		Wood effect trilobed handrail, width 40 mm	PVC + aluminium	5 wood effect colours
LINEA TOUCH - ANODISED		Trilobed aluminium handrail, width 40 mm	Aluminium	Satin silver anodised
ESCORT - PVC SHEATHED		Round handrail, diameter 40 mm	PVC + aluminium	31 colours
ESCORT - DECOWOOD		Wood effect round handrail, diameter 40 mm	PVC + aluminium	5 wood effect colours
ESCORT - ANODISED		Aluminium round handrail, diameter 40 mm	Aluminium	Satin silver anodised (or coated on request)



PERFORMER 2 p.76-77
Protection handrail



STARLINE - PVC SHEATHED p.78-79
Handrail with PVC band



STARLINE - ANODISED p.78-79
Aluminium handrail
with PVC band



STARLINE - DECOWOOD p.80-81
Aluminium handrail
with wood effect band



STARLINE - DECOTREND p.80-81
Aluminium handrail
with trend effect band



LINEA'TOUCH - PVC SHEATHED p.82-83
Trilobed handrail
width 40 mm



LINEA'TOUCH - DECOWOOD p.84-85
Wood effect trilobed handrail
width 40 mm



LINEA'TOUCH - ANODISED p.84-85
Trilobed aluminium handrail
width 40 mm



ESCORT - PVC SHEATHED p.86-87
Round handrail, diameter 40 mm



ESCORT - DECOWOOD p.88-89
Wood effect round handrail,
diameter 40 mm



ESCORT - ANODISED p.88-89
Aluminium round handrail,
diameter 40 mm



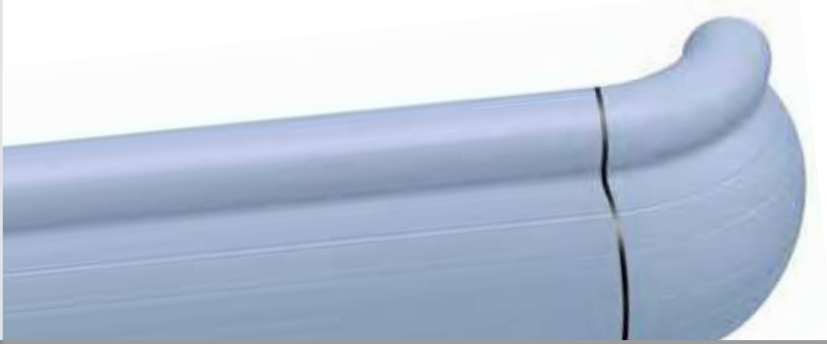

PERFORMER 2

Bactericidal joint



▶ WALL PROTECTION AND HANDRAIL

Applications

Offering both an excellent handgrip and impact resistance for corridors, this protection handrail, is ideal for all public buildings: hospitals, clinics, re-education centres, retirement homes. It benefits from a patented installation system called autoclip® which facilitates and speeds up the installation and helps to hide any faults in the wall. It is fitted with bactericidal joints.

Specification

- **Description:** Hand and wall protection rail (Performer 2 as manufactured by Gerflor) comprising 3 mm thick smooth and antibacterial PVC profile with a depth of 140 mm achieving Bs2d0 fire rating and solid colour. The system combines a completely smooth tubular upper part and a lower wall protection rail with decorative grooves. A protective film is specified to minimise cleaning before acceptance. The PVC profile snap-fixes to a continuous aluminium section and finish is provided by smooth PVC finishing accessories with decorative grooves (wall returns, 90° external angles). The unit is fitted in the spacer with adjustable in depth aluminium clamp. Overall projection is adjustable, minimum 105 mm. Bactericidal joints are provided for the junctions between profile sections and

accessories.

- **Environment:** No heavy metals and no substance potentially subjected to any REACH restriction are used in its manufacture, nor PBT/BPA. The calcium-zinc thermal stabilisation process is used. The emission level of volatile substance in inside air has been tested according to ISO 16000-6 and is very low (A+) according to the French regulation (23 March 2011 nr 2011-321 Decree and 19 April 2011 Order). 100% of the product are recyclable.
- **Colour:** Selected by architects from manufacturer's standard range.
- **Installation sequence:** Upper edge of section 0.90 m max. above floor level. Adjustable fixing on composite spacers to be fitted at 1.20 m centres (0.80 m centres in heavy traffic corridors and on light partitions like plasterboard). Wall returns fixing with pop rivets.

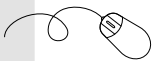

Specification and technical drawings can be downloaded from our website www.gerflor.com

Autoclip® Patented rapid installation and adjustment system

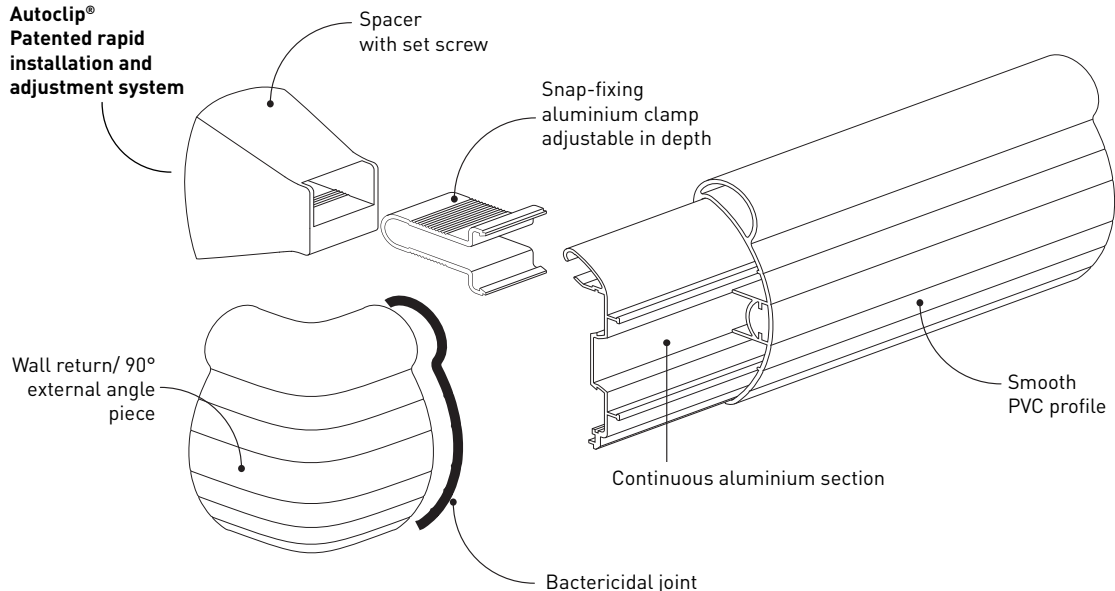

Performer 2
15 colours*



*and 16 colours on request with a minimum order quantity

Description

- Model: Performer 2 wall protection and handrail
- Section depth: 140 mm
- Length: 4 m
- Tubular upper part diameter: 40 mm
- Overall projection: Minimum 105 mm adjustable
- Stand-off from wall: Minimum 55 mm adjustable
- Material: 3 mm thick antibacterial PVC, Bs2d0 fire-rated, solid colour

- Surface finish: Smooth upper handrail, smooth wall protection rail with decorative grooves
- Fixing components: Adjustable fixing on composite spacers to be fitted at 1.20 m centres (0.80 m centres in heavy traffic corridors and on light partitions like plasterboard)
- Colours: 15 standard

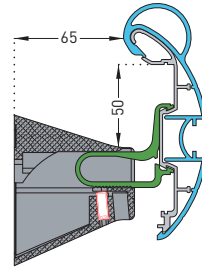

Performer 2

This version has been adapted for the UK in accordance with approved Document M to satisfy the DDA requirements

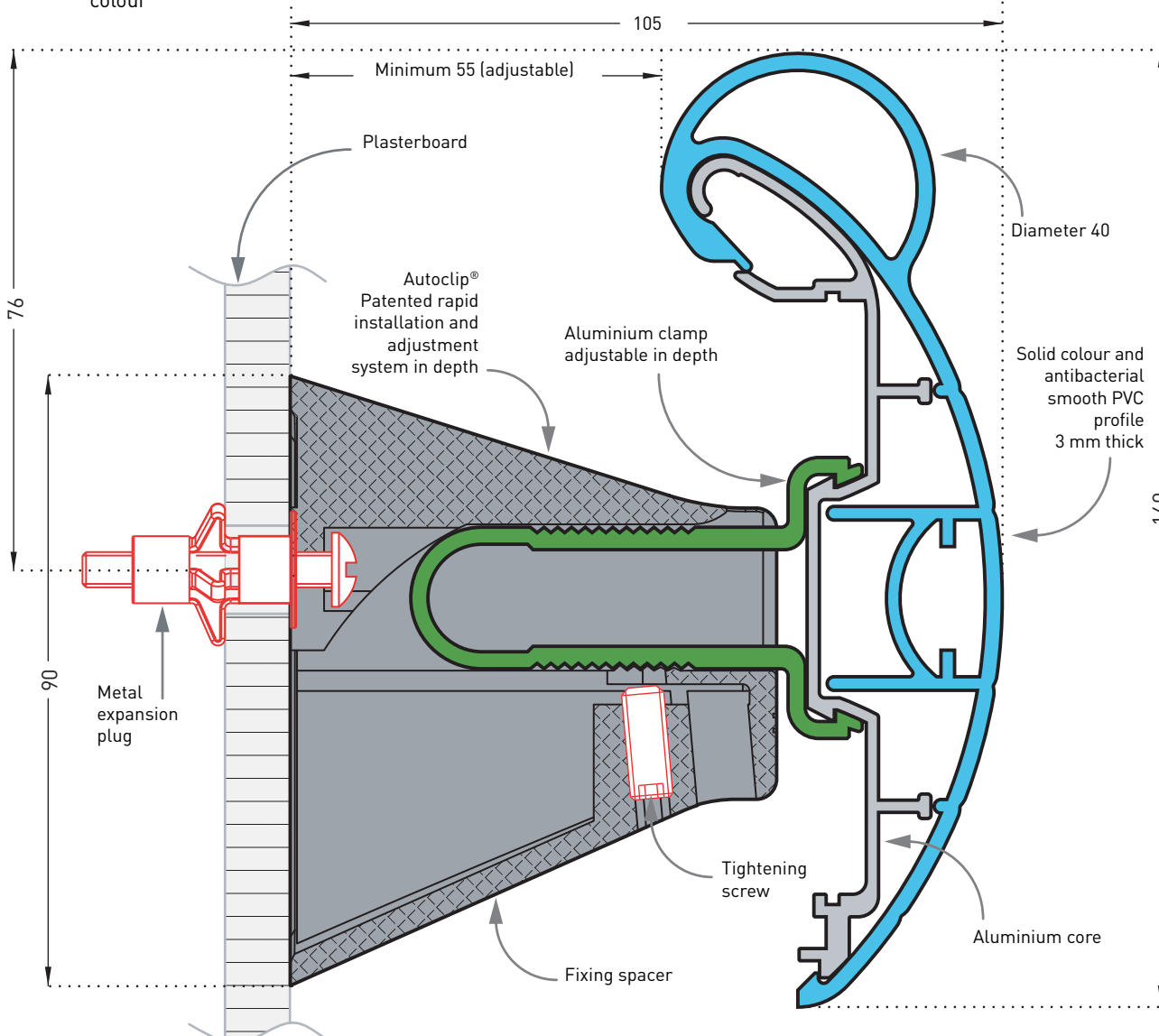

To find the colours available for each product, please see the summary table for the range at the end of this guide.



STARLINE - PVC SHEATHED

STARLINE - ANODISED

Bactericidal joint



▶ HANDRAILS WITH TWO-COLOUR PVC BAND

Applications

A combination of technology and elegant design, the Starline range is the ideal solution for all straight and curved corridor areas in public buildings: hospitals, clinics, retirement homes, hotels, offices. Starline can be bent for curved sections. A removeable system is available to provide continuation of the handrail in front of service ducts. It is fitted with bactericidal joints.

Specification

- Description: Anodised aluminium or antibacterial PVC-sheathed handrail with a lightly textured PVC band (Starline as manufactured by Gerflor). The profile is satin silver anodised aluminium or PVC-sheathed aluminium, with a groove into which the 40 mm high satin silver anodised aluminium curved brackets slide and lock. Accessories (wall returns, 90° internal and external angle pieces or made-to-measure from 90° to 160°) made of antibacterial smooth and solid colour PVC are fitted into the profile. A self-adhesive lightly textured PVC band is bonded to the rail assembly. The depth of the handrail is 90 mm, it has an overall projection of 80 mm and a thickness of 30 mm. Bactericidal joints are provided for the junctions between profile sections and accessories.

The profile can be curved.

- Environment: No heavy metals and no substance potentially subjected to any REACH restriction are used in its manufacture, nor PBT/BPA. The calcium-zinc thermal stabilisation process is used. The emission level of volatile substance in inside air has been tested according to ISO 16000-6 and is very low (A+) according to the French regulation (23 March 2011 nr 2011-321 Decree and 19 April 2011 Order). 100% of the product are recyclable.
- Colour: Selected by architects from manufacturer's standard range.
- Installation sequence: Upper edge of section 0.90 m max. above floor level. Fixes to self-locking 2-point perforated brackets screwed to the wall at 1.20 m centres (0.80 m centres in heavy traffic corridors and on light partitions like plasterboard). Wall returns fixing with pop rivets.

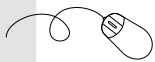

Specification and technical drawings can be downloaded from our website www.gerflor.com

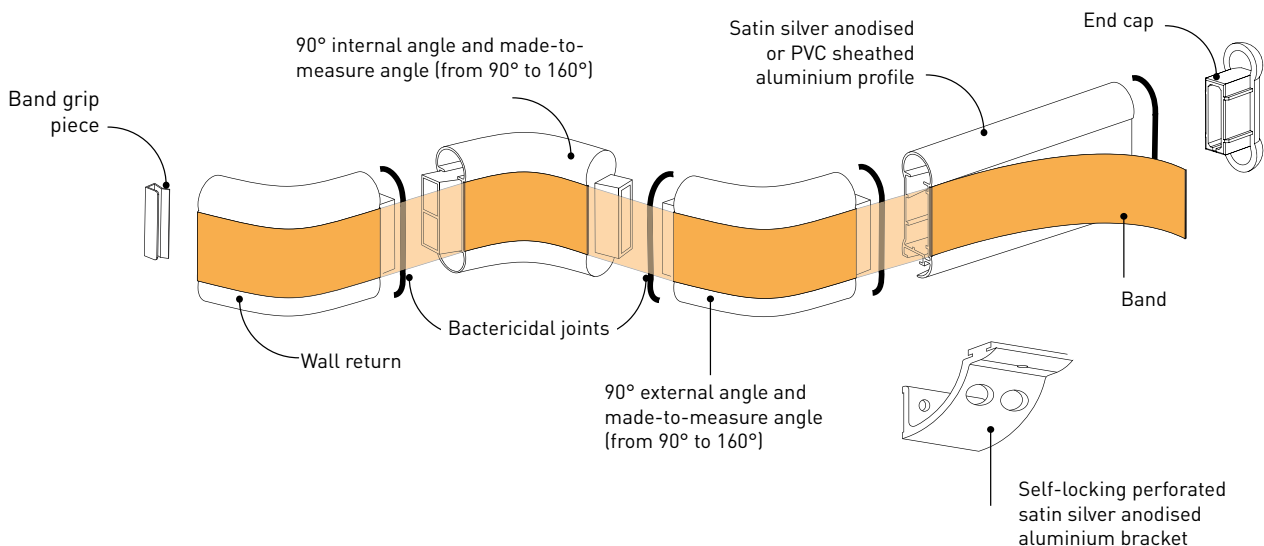



Starline band 32 colours

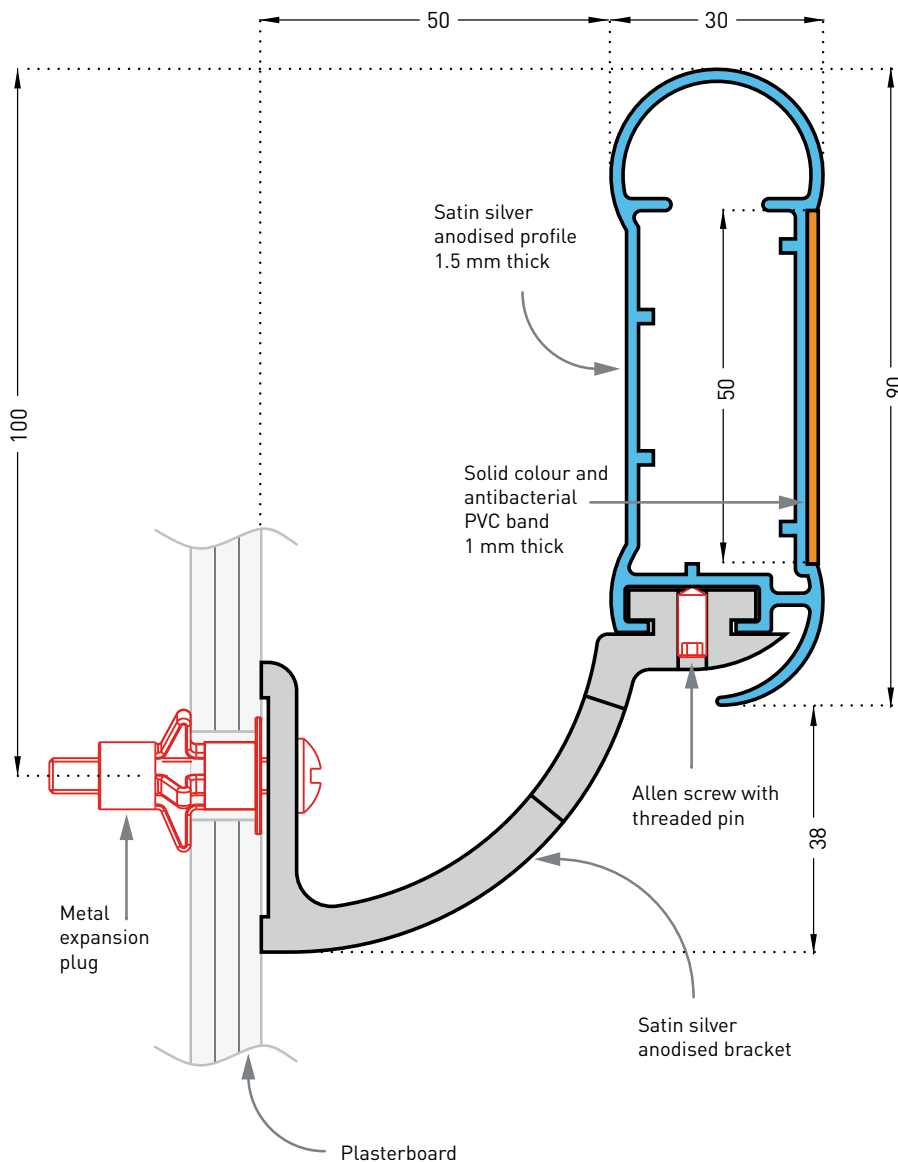

Anodised Starline

Description

- Model: Starline anodised aluminium or antibacterial PVC-sheathed handrail with a PVC band
- Section depth: 90 mm
- Length: 4 m
- Thickness: 30 mm
- Overall projection: 80 mm
- Stand-off from wall: 50 mm
- Material: Satin silver anodised aluminium profile with a PVC band, or aluminium profile with an antibacterial and Bs2d0 fire-rated PVC sheath and a PVC band, bactericidal joints
- Fixing components: 2-point self-locking perforated satin silver anodised aluminium brackets, screwed to wall at 1.20 m centres (0.80 m centres in heavy traffic corridors and on light partitions like plasterboard)
- Colours:
 - 3 finishes for aluminium profile
 - 32 colours for PVC band

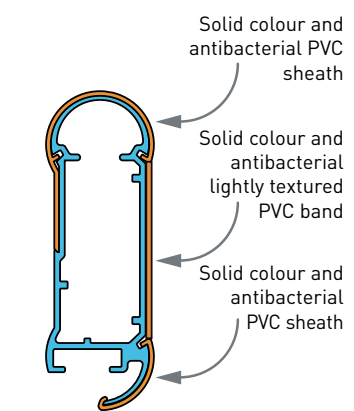

Starline with PVC sheath



STARLINE - DECOWOOD

STARLINE - DECOTREND

Bactericidal joint



▶ ALUMINIUM HANDRAILS WITH WOOD OR TREND EFFECT BAND

Applications

The Decowood or Decotrend Starline provide both a good grip and a stylish decorative touch with their wood or trend effect band. They are ideally suited for straight and curved corridor areas with light traffic of trolleys in public buildings: hospitals, clinics, retirement homes, hotels, offices. Starline can be bent for curved sections. A removeable system is available to provide continuation of the handrail in front of service ducts. They are fitted with bactericidal joints.

Specification

- Description: Anodised aluminium handrail with a wood or trend effect band (Decowood or Decotrend Starline as manufactured by Gerflor). The profile is satin silver anodised aluminium with a groove into which the 40 mm high satin silver anodised aluminium curved brackets slide and lock. Accessories (wall returns, 90° internal and external angle pieces or made-to-measure from 90° to 160°) made of antibacterial smooth silver tone PVC are fitted into the profile. A self-adhesive wood or trend effect PVC band is bonded to the rail assembly. The depth of the handrail is 90 mm, it has an overall projection of 80 mm and a thickness of 30 mm. Bactericidal joints are provided for the junctions between profile sections and accessories. The profile can be curved.

- Environment: No heavy metals and no substance potentially subjected to any REACH restriction are used in its manufacture, nor PBT/BPA. The calcium-zinc thermal stabilisation process is used. The emission level of volatile substance in inside air has been tested according to ISO 16000-6 and is very low (A+) according to the French regulation (23 March 2011 nr 2011-321 Decree and 19 April 2011 Order). 100% of the product are recyclable.
- Colour: Selected by architects from manufacturer's standard range.
- Installation sequence: Upper edge of section 0.90 m max. above floor level. Fixes to self-locking 2-point perforated brackets screwed to the wall at 1.20 m centres (0.80 m centres in heavy traffic corridors and on light partitions like plasterboard). Wall returns fixing with pop rivets.



Specification and technical drawings can be downloaded from our website www.gerflor.com

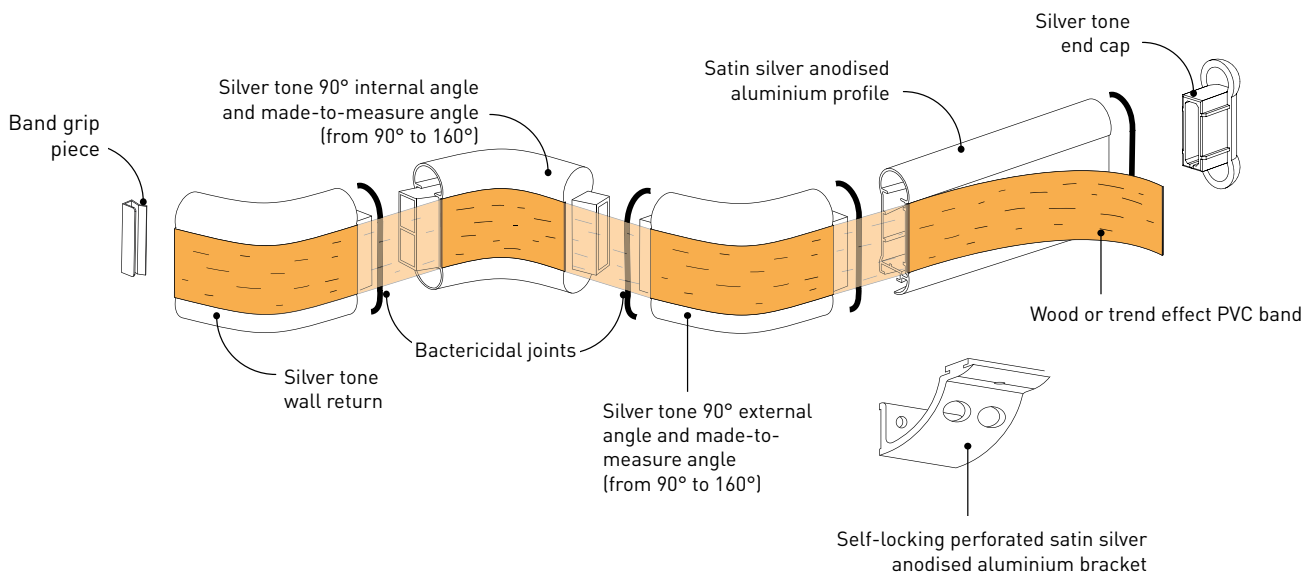

Starline band - Decowood
7 wood effect decors



Starline band - Decotrend
4 trend effect decors

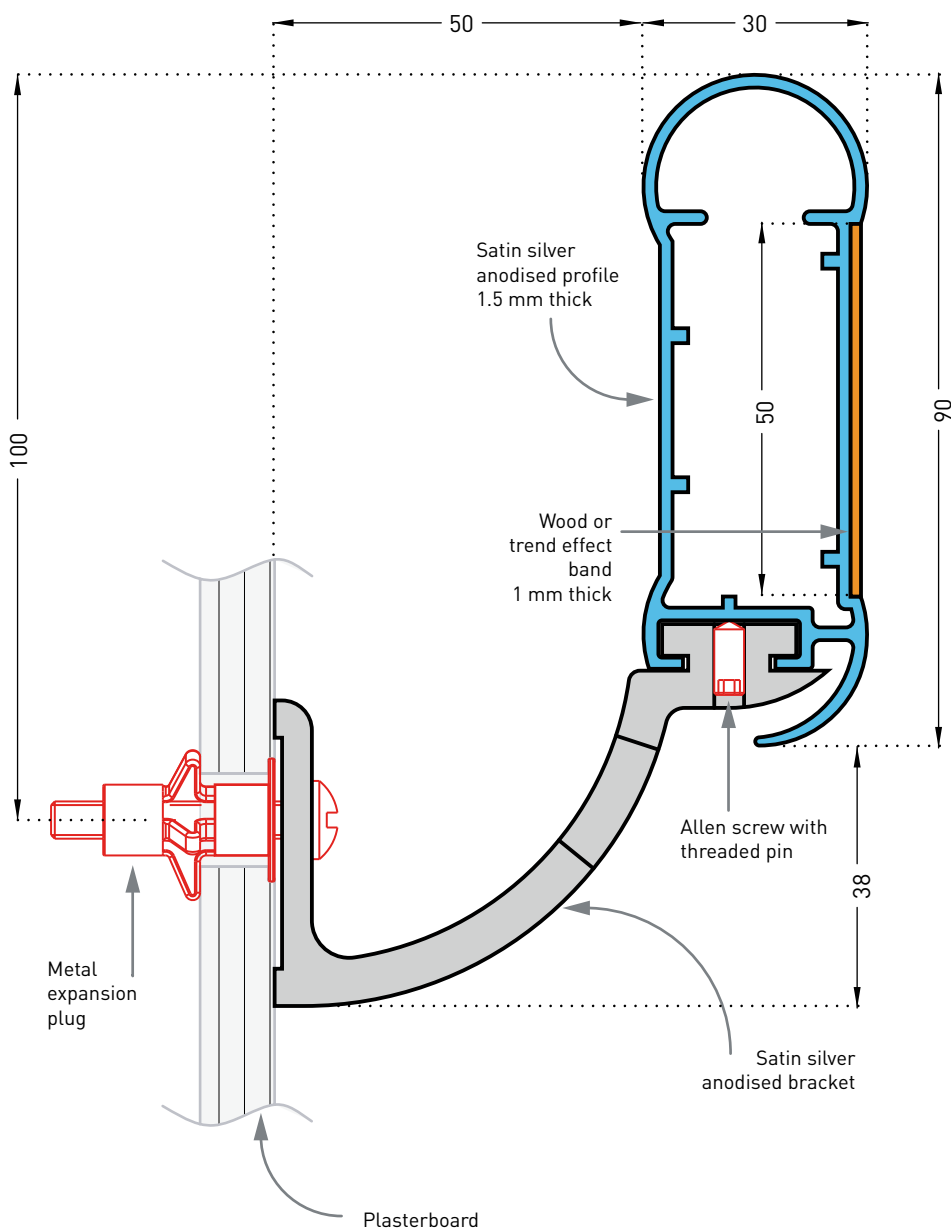

Description

- Model: Starline Decowood or Decotrend anodised aluminium handrail with wood or trend effect PVC band
- Section depth: 90 mm
- Length: 4 m
- Thickness: 30 mm
- Overall projection: 80 mm
- Stand-off from wall: 50 mm
- Material: Satin silver anodised aluminium profile with wood or trend effect PVC band achieving Bs2d0 fire rating and bactericidal joints
- Fixing components: 2-point self-locking perforated satin silver anodised aluminium brackets, screwed to wall at 1.20 m centres (0.80 m centres in heavy traffic corridors and on light partitions like plasterboard)
- Colours: 7 wood effect and 4 trend effect for the band



LINEA'TOUCH - PVC SHEATHED

Bactericidal joint



▶ TRILOBED HANDRAILS - 40 MM WIDTH

Applications

Developed with the help of architects and designers, the Linea'Touch handrail combines design, ergonomics and extreme impact resistance. Its exclusive trilobed shape validated by ergonomists provides an excellent grip while protecting the walls effectively and discreetly. Thanks to its large choice of accessories and colours for endless combinations, Linea'Touch handrail is also available in a reinforced version in order to offer an unity of design throughout the building, whatever the level of protection required. Linea'Touch can be used in all public areas, delivering aesthetic harmony from light to heavy traffic areas: hospitals, clinics, retirement homes, hotels, public buildings, offices. It can be bent and provides various technical solutions for continuity in staircases and in front of service ducts. It is fitted with bactericidal joints.

Description

- Model: PVC sheathed Linea'Touch and Linea'Touch+ (reinforced version) trilobed handrail
- Cross section: height 42 mm x width 40 mm
- Length: 4 m
- Overall Projection: 80 mm (90 mm on request)
- Stand-off from wall: 40 mm (50 mm on request)
- Material: Antibacterial and Bs2d0 fire-rated PVC, solid colour, on continuous aluminium section, bactericidal joints
- Fixing components: refined or reinforced, 2 point self-locking aluminium brackets, silver anodised effect, screwed to the wall every 1.20 m (0.80 m centres in heavy traffic areas and on light partitions like plasterboard.)
- Colours: 31 standard

Specification and technical drawings can be downloaded from our website www.gerflor.com

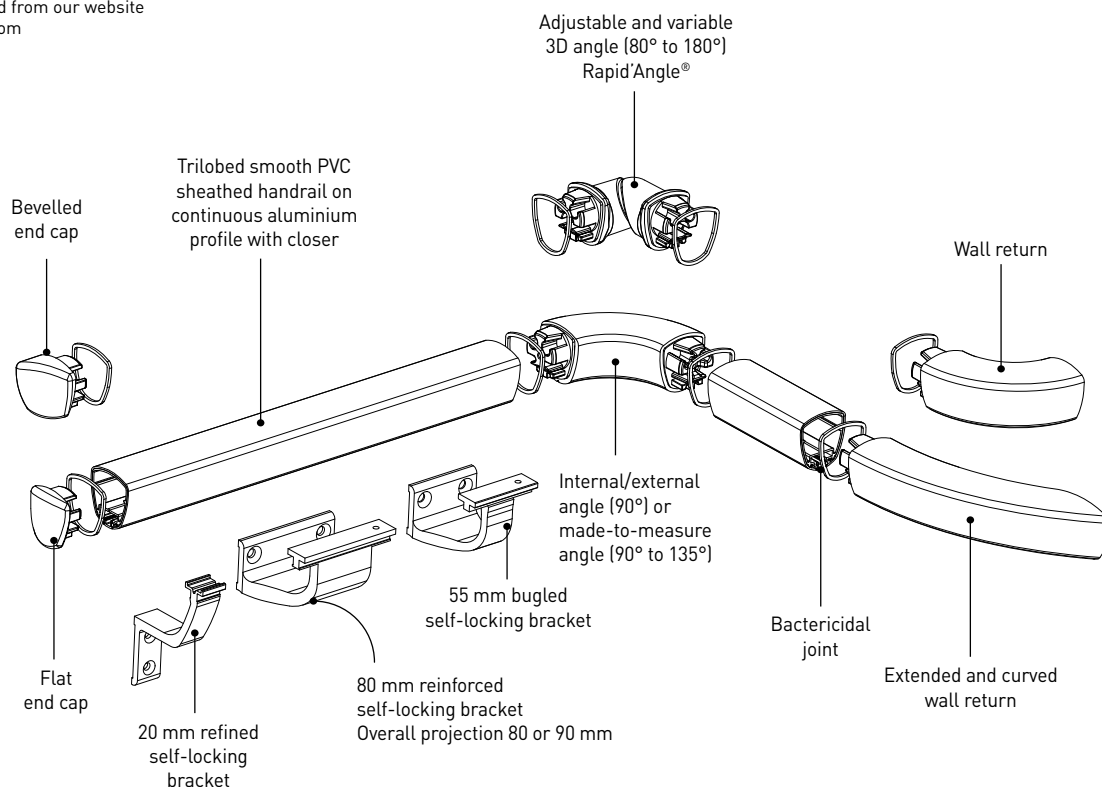

Linea'Touch
with PVC sheath
31 colours



LINEA'TOUCH

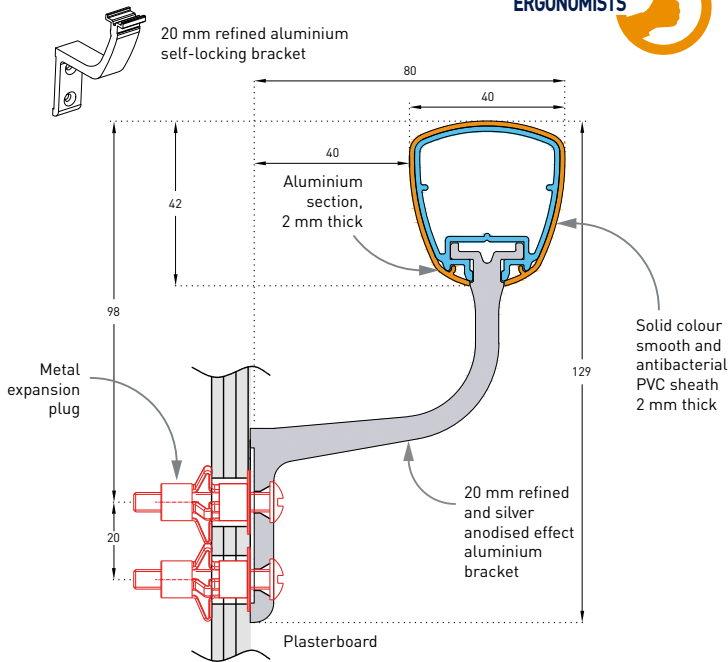

LINEA'TOUCH+
- REINFORCED VERSION -

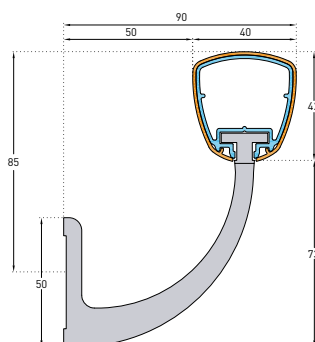
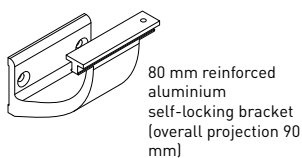
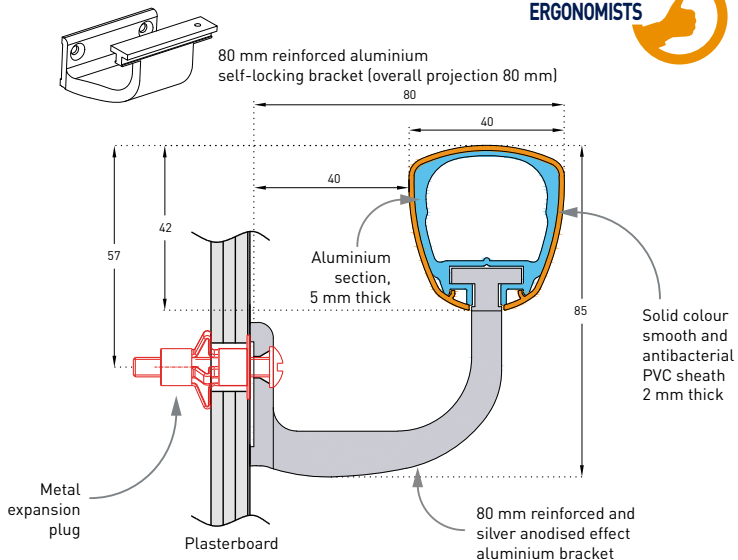

Specification

- Description: The selected PVC-sheathed handrail (Linea'Touch as manufactured by Gerflor) is a trilobed handrail with a cross section from 28 to 40 mm to give it an ergonomic and anti-rotation design. It is 42 mm deep and projects 80 mm from the wall. The axial position of its brackets provides an excellent guiding. It consists of a 2 mm continuous aluminium profile, or a 5 mm one for the reinforced version, covered with a 2 mm smooth, antibacterial, solid-colour PVC sheath and a closer underneath. A protective film is specified to minimise cleaning before acceptance. Various accessories (flat or bevelled end caps, classic or extended and curved wall returns) are available to finish the handrail assembly. All technical solutions are available to ensure continuity around corners (90° or made-to-measure), in staircases (Rapid'Angle 3-way "universal joint" rotation), across service ducts (Quick-removable assembly wedge) and around curved sections (pre-curved in the factory). These antibacterial PVC accessories connect to the profile with joiner pieces supplied with flexible bactericidal joints. Wall fixing is by aluminium brackets with 2-point self-locking attachment points: 20 mm deep refined bracket or 55 mm deep bugled bracket (for Linea Touch) or 80 mm deep reinforced bracket (for the reinforced Linea'Touch+). These handrails achieve Bs2d0 fire-rating and an impact resistance in excess of 70 Joules -i.e. an impact of more than 220 kg travelling at 2 kmh- (for Linea'Touch) and of 110 Joules -i.e. an impact of more than 320 kg travelling at 2 kmh- (for the reinforced version Linea'Touch+).
- Environment: No heavy metals and no substance potentially subjected to any REACH restriction are used in its manufacture, nor PBT/BPA. The calcium-zinc thermal stabilisation process is used. The emission level of volatile substance in inside air has been tested according to ISO 16000-6 and is very low [A+] according to the French regulation (23 March 2011 nr 2011-321 Decree and 19 April 2011 Order). 100% of the product are recyclable.
- Colour: selected by architects from manufacturer's standard range.
- Installation method: upper edge of section 0.90 m max. above floor level. Fixes to 2-point self-locking aluminium brackets at 1.20 m centres (0.80 m centres in heavy traffic areas and on light partitions like plasterboard). Wall returns, end caps and angles to be fixed with 2.5 mm Allen clamping screws.



LINEA'TOUCH - DECOWOOD

LINEA'TOUCH - ANODISED

Bactericidal joint



▶ TRILOBED WOOD EFFECT AND ALUMINIUM HANDRAILS - 40 MM WIDTH

Applications

With a wood effect or aluminium finish (satin silver anodised), the Linea'Touch handrails combine design, ergonomics and elegance.

Their exclusive trilobed shape, validated by ergonomists, provides an excellent grip discreetly. Thanks to their large choice of accessories, they fit into all insides of buildings open to the public with light traffic: corridors and staircases in retirement homes, schools, hotels, apartment blocks, public buildings, offices.

They can be bent and provide various technical solutions for continuity in staircases and in front of service ducts.

They are fitted with bactericidal joints.

Description

- Model: Linea'Touch Decowood or anodised trilobed handrail
- Section: Height 42 mm - Width 40 mm
- Length: 4 m
- Overall projection: 80 mm (90 mm on request)
- Stand-off from wall: 40 mm (50 mm on request)
- Material: 10 micron satin silver anodised aluminium or aluminium with wood effect PVC.
Bactericidal joint
- Fixing components: 2-point self-locking refined aluminium brackets, silver anodised effect screwed to wall at 1.20 m centres (0.80 m centres in heavy traffic corridors and on light partitions like plasterboard)
- Colours: 5 wood effect decors for Linea'Touch Decowood and satin silver anodised for Anodised Linea'Touch

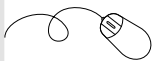

Specification and technical drawings can be downloaded from our website www.gerflor.com

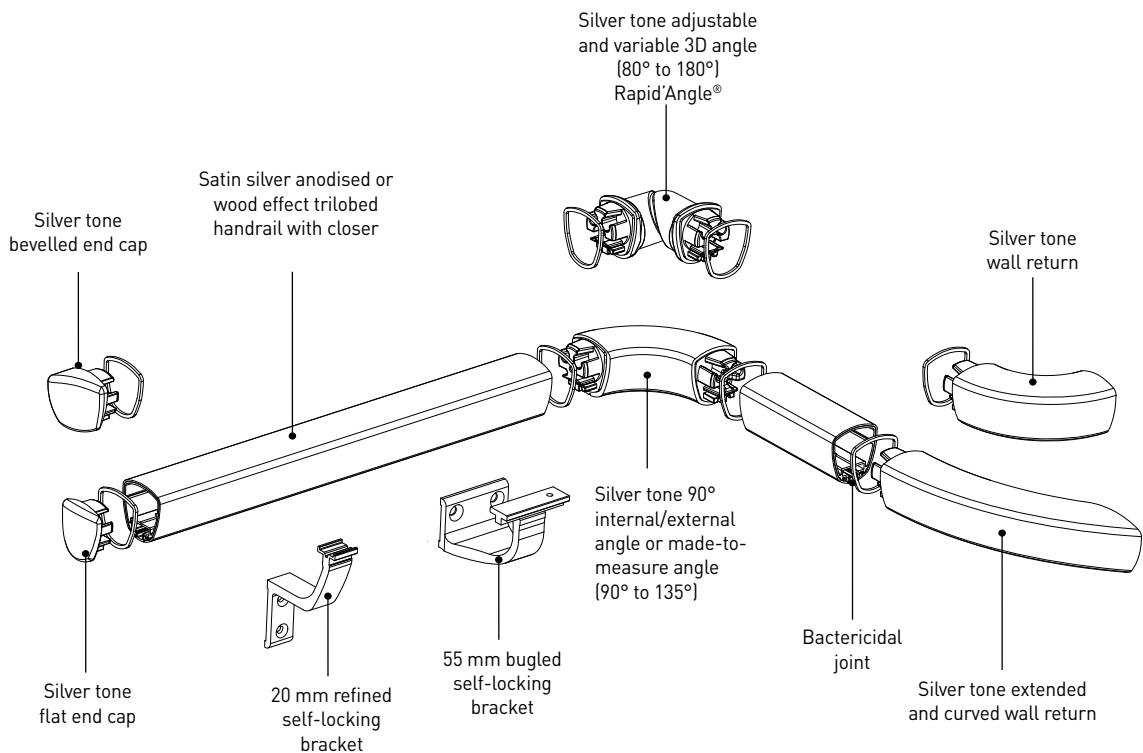

Linea'Touch - Decowood

5 wood effect decors



Linea'Touch Anodised

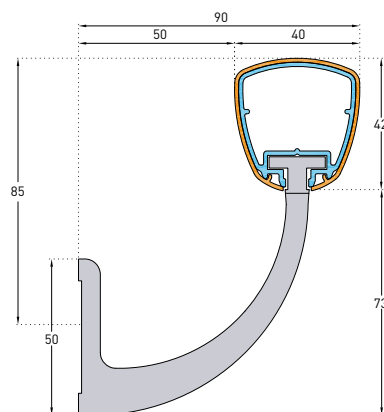
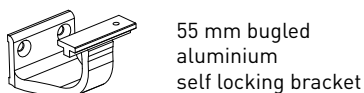
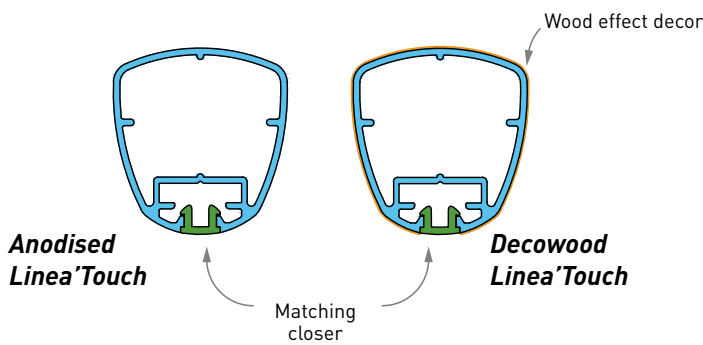
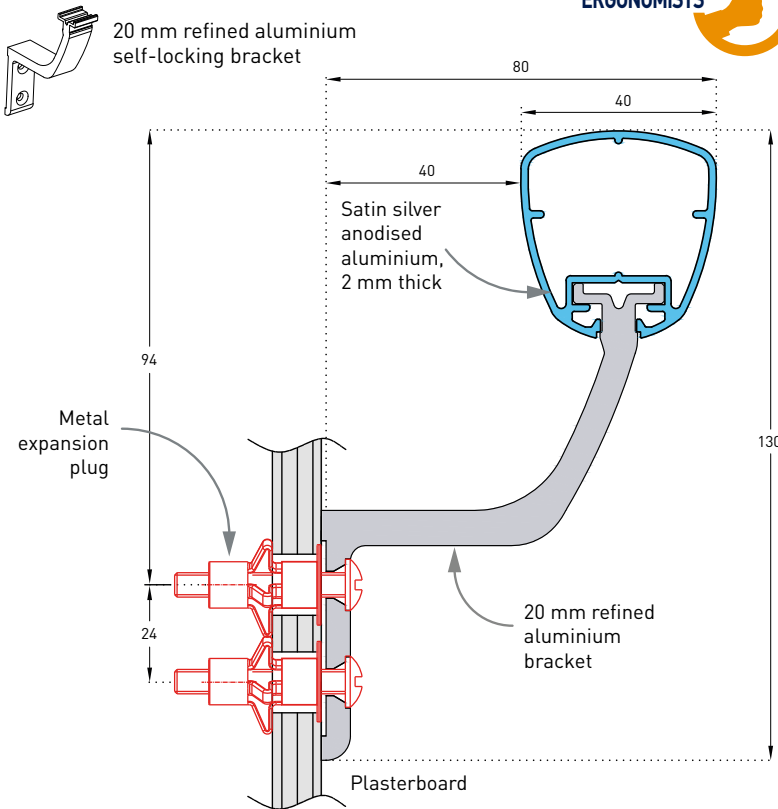

Specification

- **Description:** The selected wood effect or anodised handrail (Decowood Linea'Touch or Anodised Linea'Touch as manufactured by Gerflor) is a trilobed, wood effect PVC or satin silver anodised handrail with a cross section from 28 to 40 mm to give it an ergonomic and anti-rotation design. It is 42 mm deep and projects 80 mm from the wall. The axial position of its brackets provide an excellent handhold. It consists of a 2 mm satin silver anodised aluminium profile (anodised Linea'Touch) or of a 2 mm aluminium profile covered with wood effect PVC film (Decowood Linea'Touch) and a closer underneath. A protective film is specified to minimise cleaning before acceptance. Various accessories in silver tone PVC (flat or bevelled endcaps, classic or extended and curved wall returns) are available to finish the handrail assembly. All technical solutions are available to ensure continuity around corners (90° or made-to-measure), in staircases (Rapid'Angle 3-way "universal joint" rotation), across service ducts (Quick-removable assembly wedge) and around curved sections (pre-curved in the factory). These antibacterial PVC accessories connect to the profile with joiner pieces supplied with flexible bactericidal joints. Wall fixing is by 20 mm refined aluminium brackets with 2 self-locking attachment points. This handrail achieves Bs2d0 fire-rating and an impact resistance in excess of 70 Joules, i.e., an impact of more than 220 kg travelling at 2 kmh.

- **Environment:** : No heavy metals and no substance potentially subjected to any REACH restriction are used in its manufacture, nor PBT/BPA. The calcium-zinc thermal stabilisation process is used. The emission level of volatile substance in inside air has been tested according to ISO 16000-6 and is very low (A+) according to the French regulation (23 March 2011 nr 2011-321 Decree and 19 April 2011 Order). 100% of the product are recyclable.

- **Colour:** selected by architects from manufacturer's standard range.

- **Installation method:** upper edge of section 0.90 m max. above floor level. Fixes to 2-point self-locking aluminium brackets at 1.20 m centres (0.80 m centres in heavy traffic areas and on light partitions like plasterboard). Wall returns, end caps and angles to be fixed with 2.5 mm Allen clamping screws.

To find the colours available for each product, please see the summary table for the range at the end of this guide.



ESCORT - PVC SHEATHED

Bactericidal joint



Bactericidal treatment on request

▶ DIAMETER 40 MM ROUND HANDRAIL

Applications

Escort is designed to provide a high quality grip and classic look. Highly appreciated by mobility-impaired persons for its perfect roundness and pleasant feel, Escort 40 is ideal for all corridors and stairways in retirement homes, hospitals, clinics, rehabilitation centres, collective housing. Escort can be bent for curved sections. A removeable system is available to provide continuation of the handrail in front of service ducts. It is fitted with bactericidal joints.

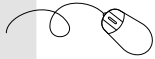

Specification and technical drawings can be downloaded from our website www.gerflor.com

Specification

• Description : Round handrail with antibacterial PVC sheath (Escort PVC sheathed as manufactured by Gerflor) with a diameter of 40 mm. The rail consists of an aluminium section covered by a sheath of smooth and antibacterial PVC achieving Bs2d0 fire rating with solid colour. A protective film is specified to minimise cleaning before acceptance. The section comprises a groove into which brackets, accessories and matching closer slide and lock. Perforated brackets are curved, 40 mm deep and made of satin silver anodised aluminium. Overall projection and depth are 80 mm. Accessories made of smooth antibacterial PVC (wall returns, round or flat end caps external and internal 90° angle pieces or made-to-measure from 90 to 165°), and supplied with bactericidal joints, are fitted on the section and fixed with locking screws. All technical solutions are available to ensure continuity around corners (90° or made-to-measure), in staircases (slope link or 3-way "universal joint" rotation angle -Rapid'Angle as manufactured by Gerflor-), across service

ducts (quick-removable assembly wedge and articulated link -Rapid'Access as manufactured by Gerflor-) and around curved sections (pre-curved in the factory).

• Environment : No heavy metals and no substance potentially subjected to any REACH restriction are used in its manufacture, nor PBT/BPA. The calcium-zinc thermal stabilisation process is used. The emission level of volatile substance in inside air has been tested according to ISO 16000-6 and is very low (A+) according to the French regulation (23 March 2011 nr 2011-321 Decree and 19 April 2011 Order). 100% of the product are recyclable.

• Colour: selected by architects from manufacturer's standard range
 • Installation method: upper edge of section 0.90 m max. above floor level. Fixes to 2-point self-locking perforated aluminium brackets at 1.20 m centres (0.80 m centres in heavy traffic areas and on light partitions like plasterboard). Wall returns, end caps and angles to be fixed with 2.5 mm Allen clamping screws.

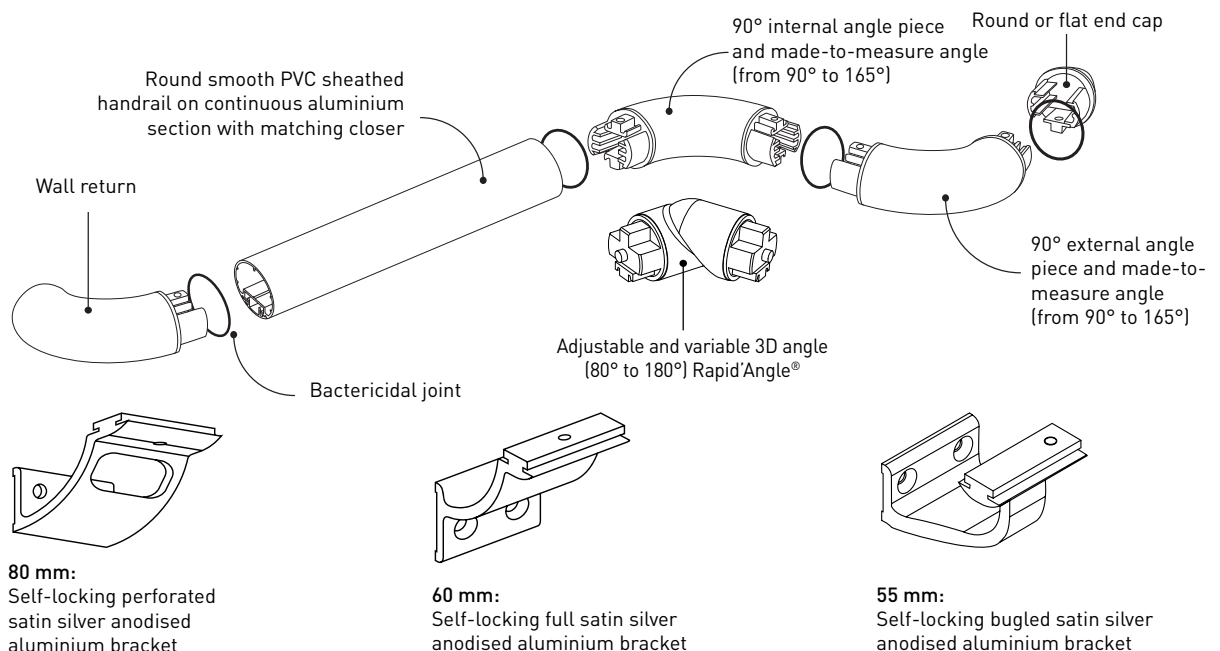

80 mm:
Self-locking perforated satin silver anodised aluminium bracket

60 mm:
Self-locking full satin silver anodised aluminium bracket

55 mm:
Self-locking bugled satin silver anodised aluminium bracket

Escort
31 colours

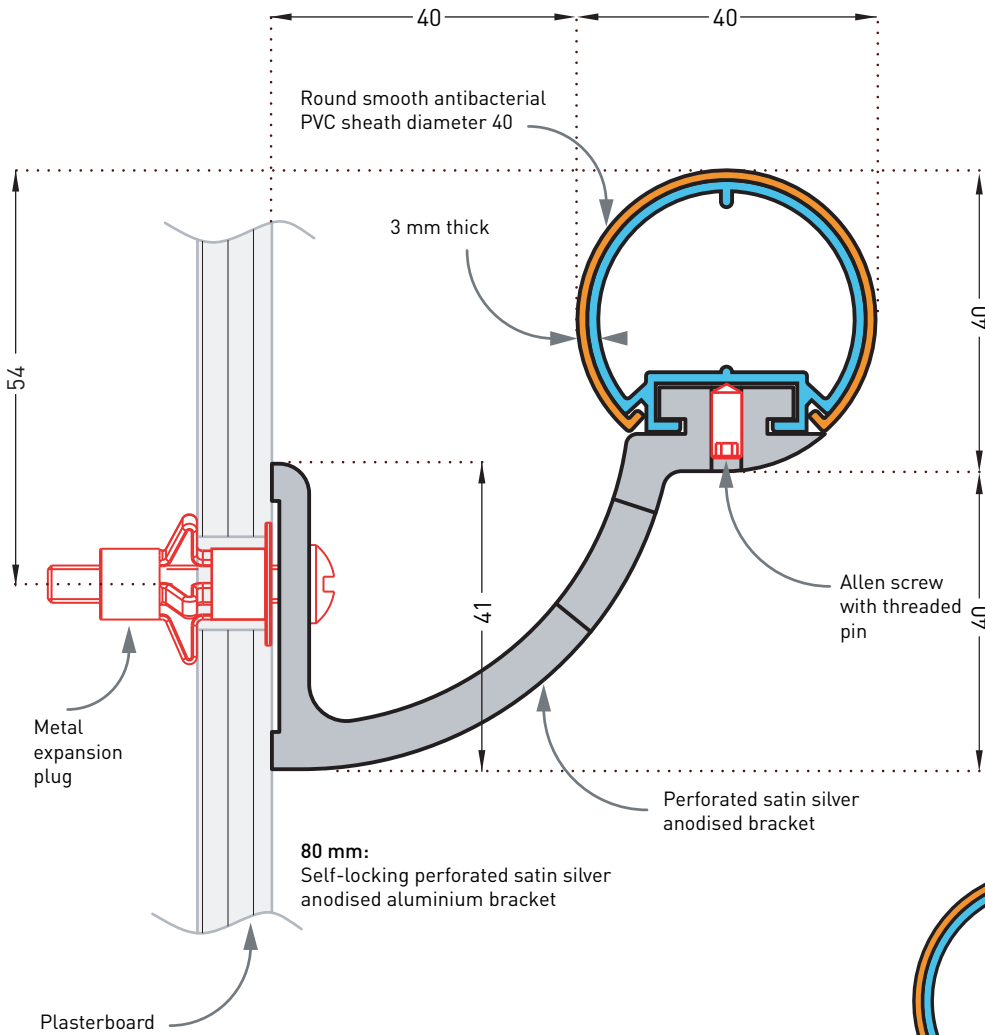
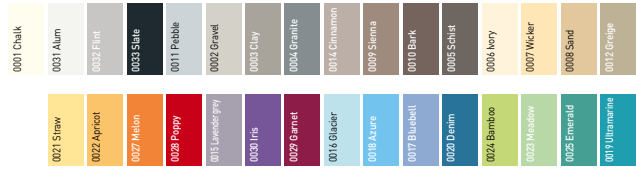

Description

- Model: Escort round PVC sheathed handrail
- Diameter: 40 mm
- Length: 4 m
- Overall projection: 80 mm
- Stand-off from wall: 40 mm
- Material: Antibacterial and Bs2d0 fire-rated PVC, solid colour, on continuous aluminium section, bactericidal joints
- Fixing components: 2-point self-locking perforated brackets, satin silver anodised aluminium finish, screwed to wall at 1.20 m centres (0.80 m centres in heavy traffic areas and on light partitions like plasterboard)
- Colours: 31 standard

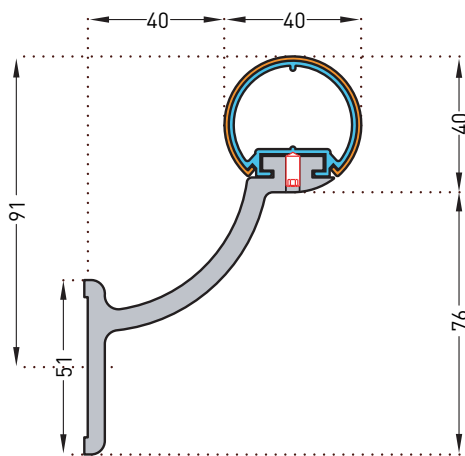

60 mm:
Self-locking full satin silver anodised aluminium bracket

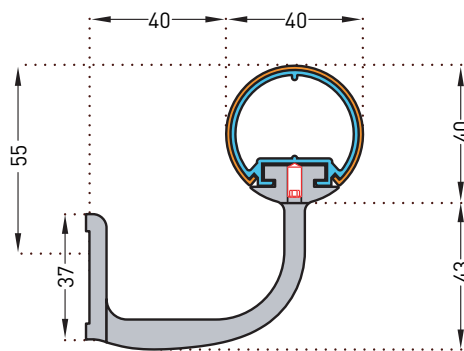

55 mm:
Self-locking bugled satin silver anodised aluminium bracket

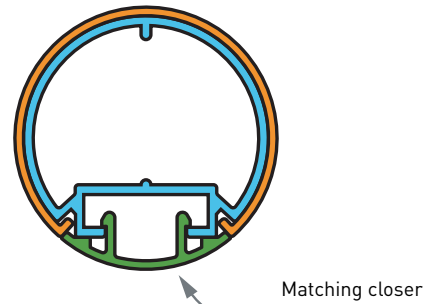



ESCORT - DECOWOOD

ESCORT - ANODISED

Bactericidal joint



▶ DIAMETER 40 MM ROUND HANDRAILS

Applications

Particularly elegant handrails with a wood effect or an aluminium finish (satin silver anodised) and curved, unobtrusive brackets. They are ideal for all buildings open to the public: corridors and stairways in retirement homes, schools, hotels, residential apartment buildings, offices, etc. Escort can be bent for curved sections. A removeable system is available to provide continuation of the handrail in front of service ducts. They are fitted with bactericidal joints.

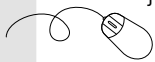

Specification and technical drawings can be downloaded from our website www.gerflor.com

Specification

- Description: Round wood effect handrail with a diameter of 40 mm (Decowood Escort as manufactured by Gerflor) or in satin silver anodised aluminium (Anodised Escort as manufactured by Gerflor), 1.5 mm thick. A protective film is specified to minimise cleaning before acceptance. The aluminium profile comprises a groove into which brackets, accessories and matching closer slide and lock. Perforated brackets are curved, 40 mm deep and made of satin silver anodised aluminium. Overall projection and depth are 80 mm. Smooth accessories made of wood effect or silver tone or chromium look PVC (wall returns, flat or round end caps, external and internal 90° angle pieces or made-to-measure from 90° to 165°), and supplied with bactericidal joints, are fitted on the section and fixed with locking screws. All technical solutions are available to ensure continuity around corners (90° or made-to-measure), in staircases (silver tone slope link or 3-way "universal joint" rotation angle -Rapid'Angle as manufactured by Gerflor-), across service

ducts (quick-removable assembly wedge and silver tone articulated link -Rapid'Access as manufactured by Gerflor-) and around curved sections (pre-curved in the factory).

- Environment : No heavy metals and no substance potentially subjected to any REACH restriction are used in its manufacture, nor PBT/BPA. The calcium-zinc thermal stabilisation process is used. The emission level of volatile substance in inside air has been tested according to ISO 16000-6 and is very low (A+) according to the French regulation (23 March 2011 nr 2011-321 Decree and 19 April 2011 Order). 100% of the product are recyclable.
- Colour: selected by architects from manufacturer's standard range
- Installation method: upper edge of section 0.90 m max. above floor level. Fixes to 2-point self-locking perforated aluminium brackets at 1.20 m centres (0.80 m centres in heavy traffic areas and on light partitions like plasterboard). Wall returns, end caps and angles to be fixed with 2.5 mm Allen clamping screws.

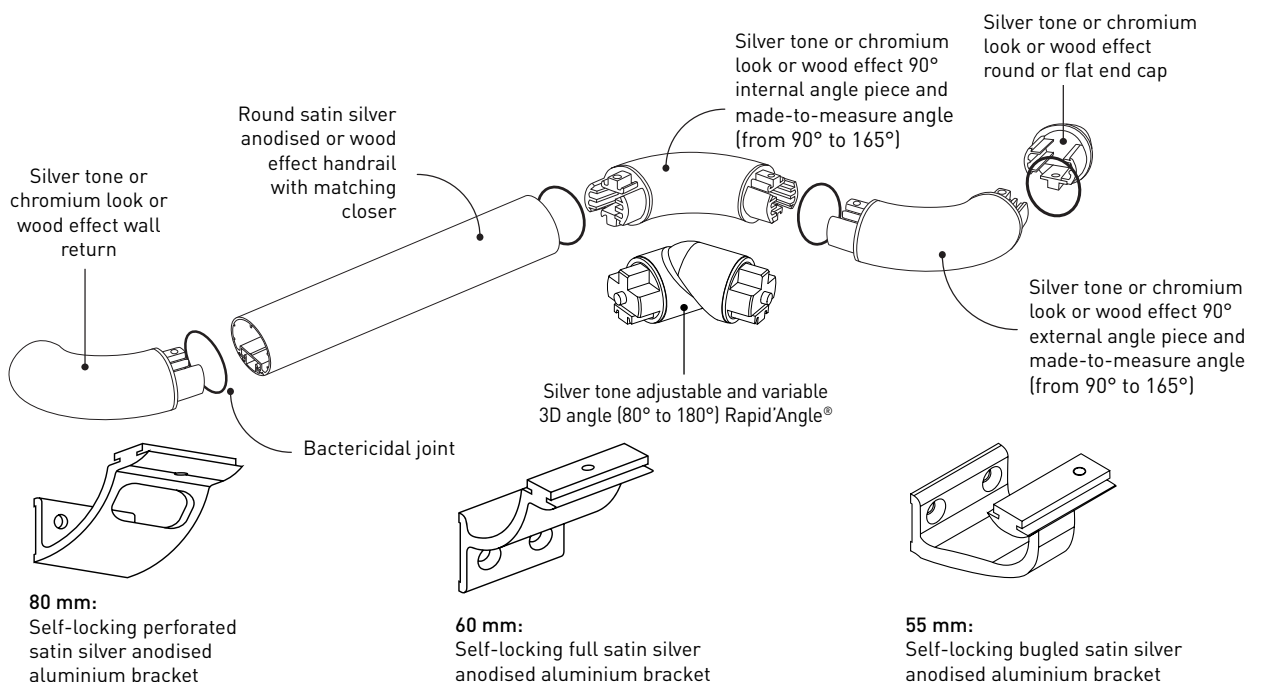

Escort - Decowood
3 finishes
for accessories



Escort - Decowood
5 wood effect colours



Escort - Anodised

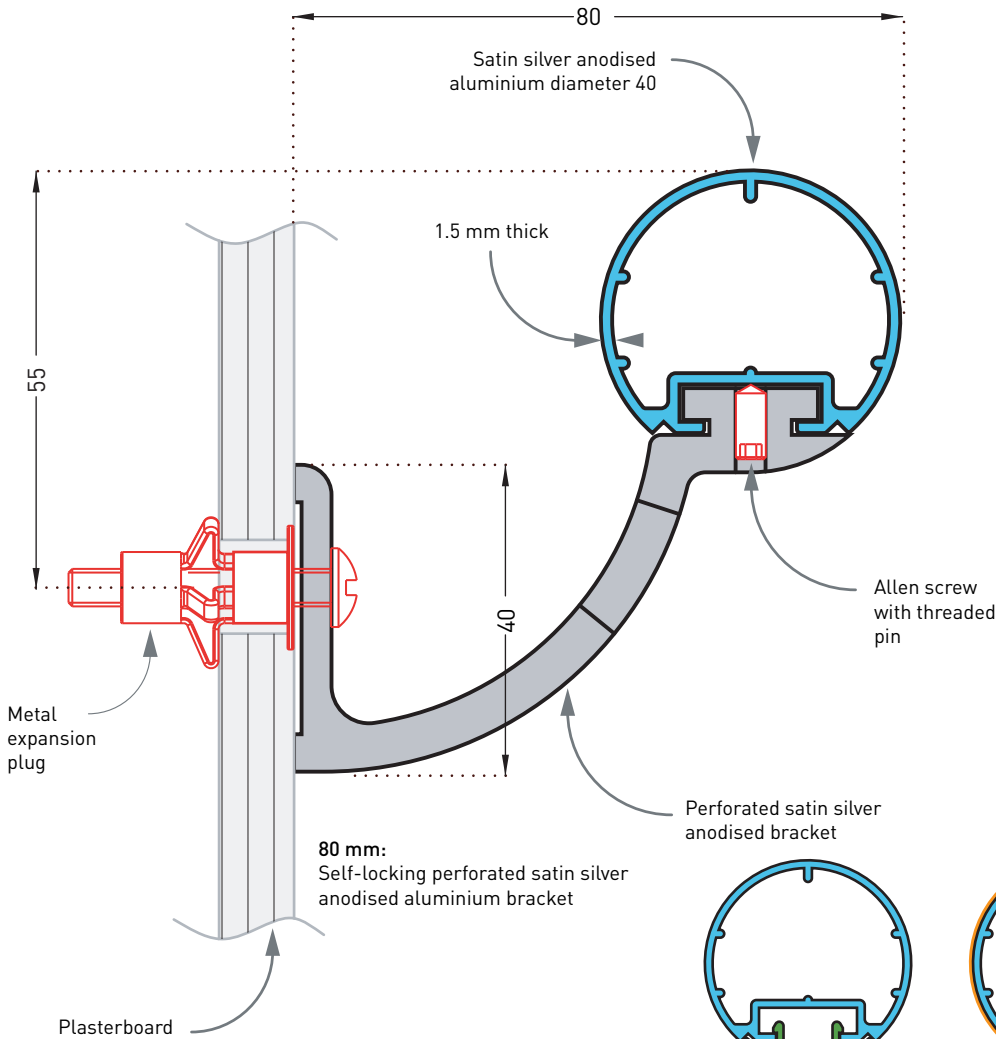

Description

- Model: Escort anodised or Decowood round handrail
- Diameter: 40 mm
- Length: 4 m
- Overall projection: 80 mm
- Stand-off from wall: 40 mm
- Material: 10 micron satin silver anodised aluminium or wood effect PVC
- Fixing components: 2-point self-locking perforated brackets, satin silver anodised aluminium finish, screwed to wall at 1.20 m centres (0.80 m centres in heavy traffic corridors and on light partitions like plasterboard)
- Colours: 5 wood effect colours for Escort Decowood or satin silver anodised for anodised Escort. Coating on request.

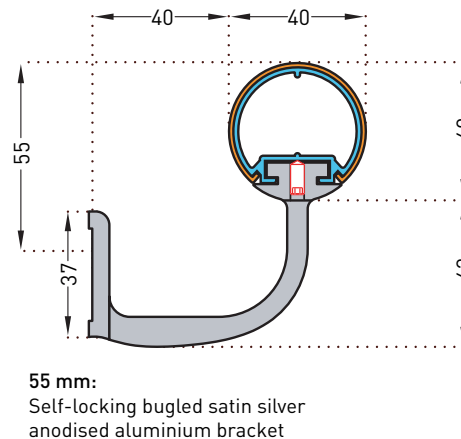
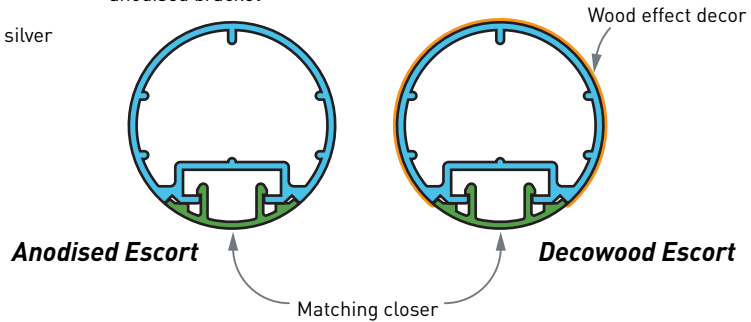
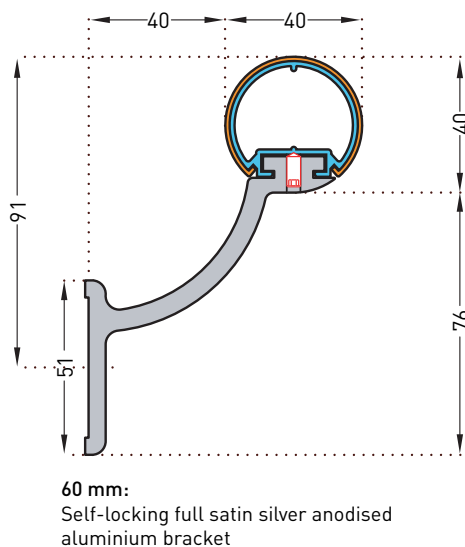

Find out more about technical solutions at the end of the guide.

To find the colours available for each product, please see the summary table for the range at the end of this guide.



Safycorner
4 colours



SAFYCORNER



▶ 90° ADHESIVE CUSHIONING CORNER PROTECTOR

Applications

The Safycorner cushioning corner protector is designed to protect individuals from impacts against a protruding corner. Made from a flexible elastomer, it has a high impact absorption capacity and minimises the risk of injury. It has two strips of double-sided adhesive tape and a protective film for ease of installation and cleaning. Ideal for childcare settings, retirement homes, specialist institutions, gyms and sports halls.

Description

- Model: Safycorner adhesive cushioning corner protector
- Angle: 90°
- Wing width: 25 mm (internal measurement)
- Thickness: 11 mm
- Length: 1.30 m
- Material: solid colour elastomer
- Surface finish: smooth
- Fixing: adhesive foam strips
- Colours: 4 standard

Specification

- Description: 25 mm wide wings (internal measurement) 90° adhesive cushioning corner protector (Safycorner as manufactured by Gerflor) comprising a 10 mm thick smooth and flexible elastomer section with solid colour, covered with a 1 mm thick transparent protective film to reduce cleaning throughout its service life. It is provided with 2 strips of foam adhesive tape for fixing.
- It has an impact absorption capacity of 38%, thus minimising the risk of injury.
- Environment: no heavy metals are used in its formulation, including lead or tin or any CMR Cat 1 or 2 substances, nor PBT/BPA. This allows off-cuts to be 100% recycled and meets the 7 targets of the HQE building standard.
- Colours: selected by architects from manufacturer's standard range.
- Installation method: adhesive.



Specification and technical drawings can be downloaded from our website www.gerflor.com

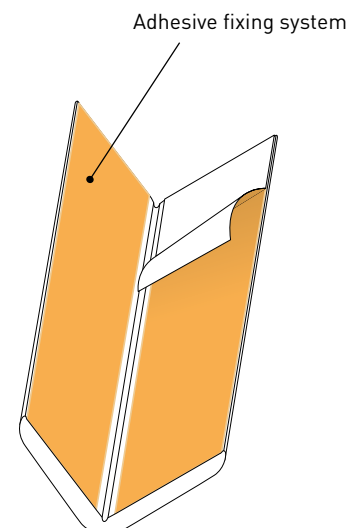
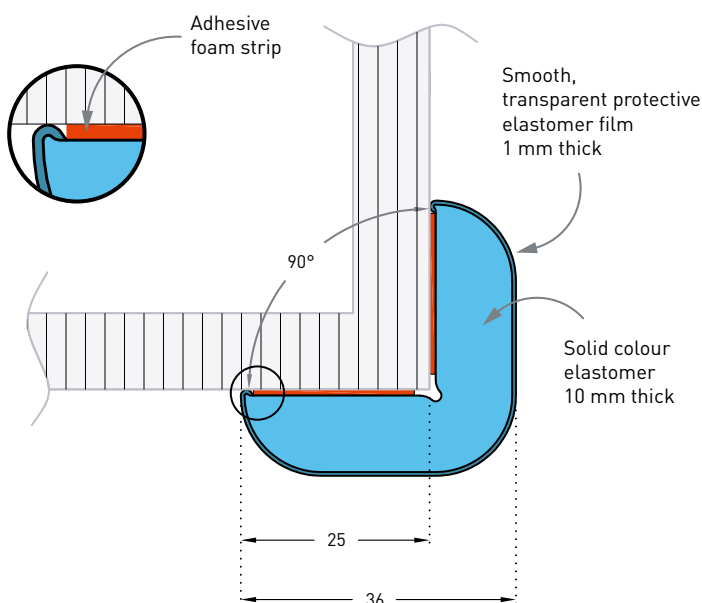



Rabet side

Hinge side



Safydoor
4 colours



SAFYDOOR



▶ DOOR FINGER PROTECTION SYSTEM

Applications

The door finger protection system Safydoor is the ideal solution for making both single and swing doors safe. The special shape of the strong, flexible bellows prevents fingers from getting into door rabbets. The door finger protection system Safydoor improves safety in locations frequented by young children as well as in workplaces, preventing a major cause of accidents and protecting individuals from often serious after-effects.

Description

- Model: Safydoor door finger protection system
- Height: 1.40 m
- Width: 170 mm (rabet side) and 70 mm (hinge side)
- Material: 2-mm thick solid colour elastomer
- Surface finish: smooth
- Fixing: on pre-drilled aluminium cores
- Colours: 4 standard

Specification

- Description: door finger protection system (Safydoor as manufactured by Gerflor) to prevent fingers being trapped when opening and closing doors, comprising two solid colour, flexible elastomer sections 1.40 m in height, that slot into two pre-drilled aluminium cores. The 7-bellows section is used on the inside door jamb (rabet side) and can cover a 150-mm gap, with the bellows providing additional extension up to 190 mm. The 3-bellows section is used on the outside door jamb (hinge side) and is designed to move with the door, compressing on opening by 20 to 80 mm.
- Environment: no heavy metals are used in its formulation, including lead or tin or any CMR Cat 1 or 2 substances, nor PBT/BPA. This allows off-cuts to be 100% recycled and meets the 7 targets of the HQE building standard.
- Colours: selected by architects from manufacturer's standard range.
- Installation method: snap-fixes to pre-drilled aluminium cores screwed to the door and frame.

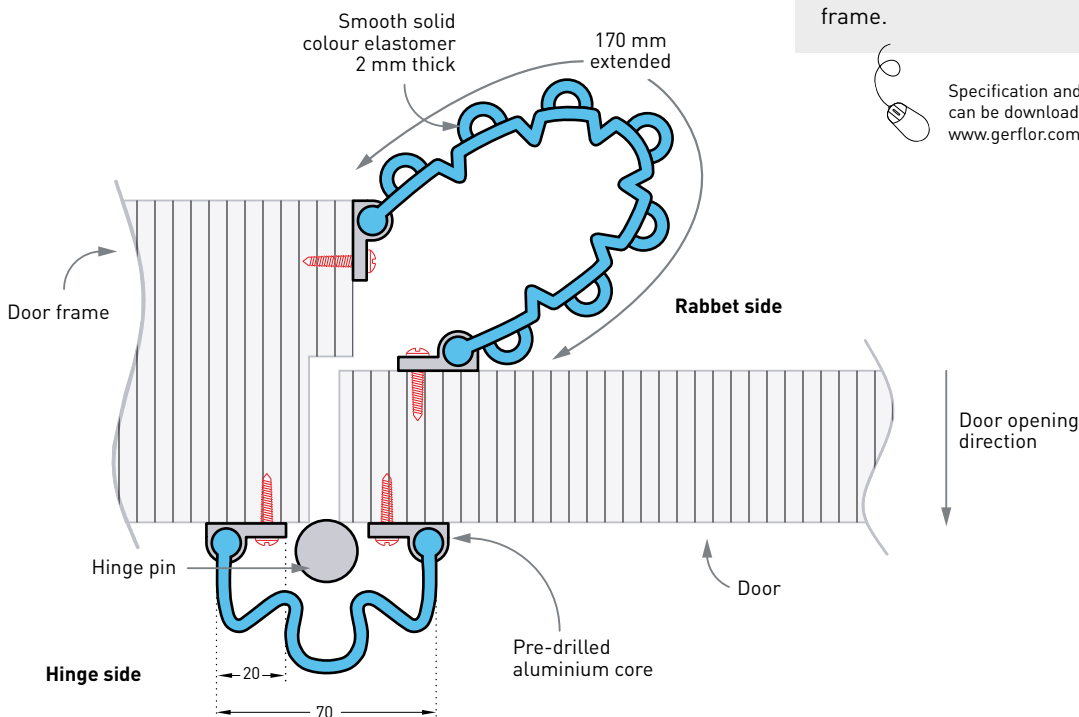

Specification and technical drawings can be downloaded from our website www.gerflor.com

Individual protection

Find out more about technical solutions at the end of the guide.

To find the colours available for each product, please see the summary table for the range at the end of this guide.

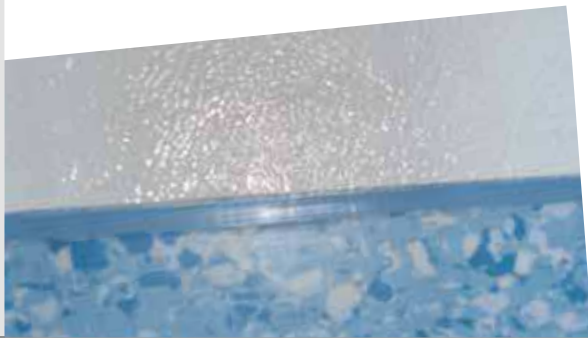

SOLUTIONS FOR PANELS

THERMO-WELDING

▶ HOT WELDED JOINTS

Applications

SPM Decochoc, Decowood, Decotrend, Decoclean and Decochoc H₂O panels are made of antibacterial PVC. They are easy to clean and can be installed:

- from floor to ceiling with welded joints
- in right or curved corners, whatever the degrees or the radius
- above the skirting of PVC floor coverings.

For a reliable watertightness, Gerflor has a range of welding rods matched to the colours of SPM profiles, allowing you to hot weld one panel to another.

Gerflor also provides a global solution for absolute water tightness and reliable junction: hot welded joints between the skirting of the floor covering and the wall panel.

This system is optimised to work with the exclusive Gerflor Clean Corner System, and is particularly recommended for operating rooms and other rooms requiring a high level of hygiene.

Description

- Model: Gerflor welding rod
- Diameter: 4 mm
- Length: 100 m roll
- Material: Flexible PVC
- Fixing: hot welded with welding machine
- Colours: 32 standard and 5 for Decochoc H₂O



THERMOFORMING



PILLAR AND DOOR FRAME PROTECTION WITH DECOCHOC, DECOSMIC, DECOWOOD AND DECOTREND PANELS

Applications

In order to adapt to all building layouts, Decochoc, Decosmic, Decowood and Decotrend panels can be thermoformed to cover round pillars (diameter less than 800 mm) and complex door frames that can not be protected with simple L or U bends.

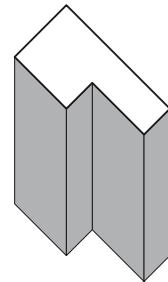
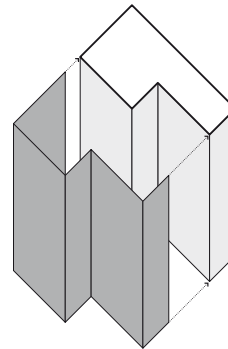
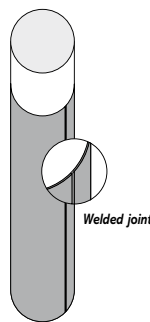
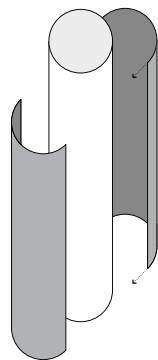

FIXING & FINISHING



SPM universal primer
(100 to 150 g required per m²)
5 l drum



Silicone joint for Decochoc, Decosmic, Decowood, Decotrend, Decoclean, and Decochoc H₂O panels (matching colours)
310 ml cartridge



Welding rod for Decochoc, Decowood, Decotrend, Decoclean and Decochoc H₂O panels (matching colours)
100 m roll



SPM solvent-free **acrylic glue** - Simple bonding
(300 to 350 g required per m²) - Available in 6 or 14 kg jars



SPM **multi-purpose adhesive mastic** - solvent-free
290 ml cartridge (about 25 ml of cord)



Double-sided foam adhesive roll 4957/15 mm wide
(contact us prior to use) - 25 m roll



Double-sided adhesive roll 4970/45 mm wide
For installation on doors or laminates
(contact us prior to use) - 50 m roll



SOLUTIONS FOR HANDRAILS

▶ IN FRONT OF SERVICE DUCTS

Applications

Quick-removable system (assembly wedges) designed to make easy access to service duct gates whilst providing continuation of the handrails and secure handgrip for people. Available for Escort, Linea'Touch and Starline handrails.

Service duct gates longer than 800 mm.

It is necessary to place a quick-removable bracket onto the service duct access gate.

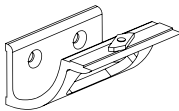

Starline handrail

For Starline handrail, Gerflor can provide a 800 mm ready-to-install kit.

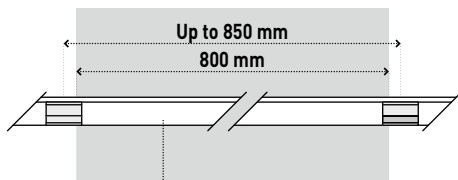

800 mm length of Starline profile, especially machined for service duct. (Other sizes available on request)

For Escort and Linea'Touch handrails, the service duct kit is installed on site :

- by cutting the profile to the length of the access gate using two 45° cuts and two quick-removable assembly wedges

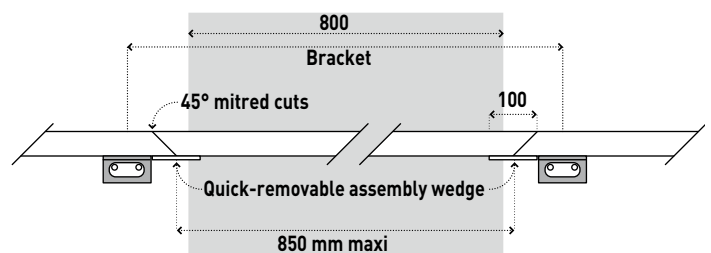

For Escort handrail, Rapid'Access, the articulated link has been especially designed for service duct, to complete with one quick-removable assembly wedge.

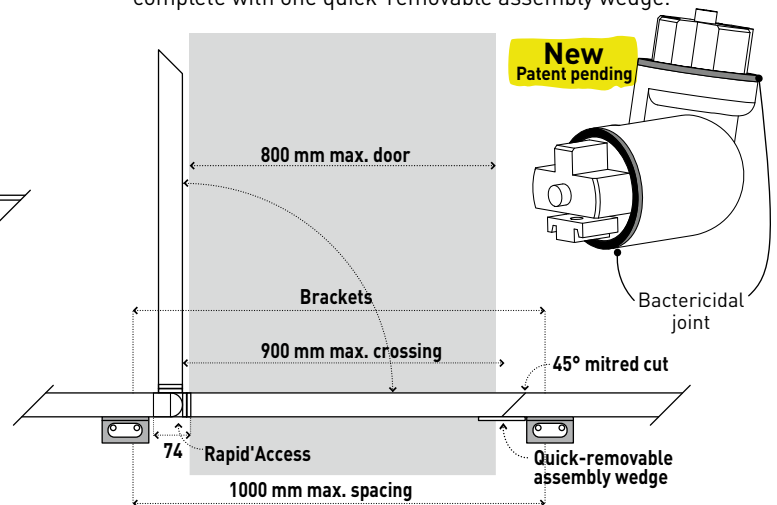

▶ CURVING

Applications

Curving of Starline, Linea'Touch and Escort handrails to fit in different building layouts.

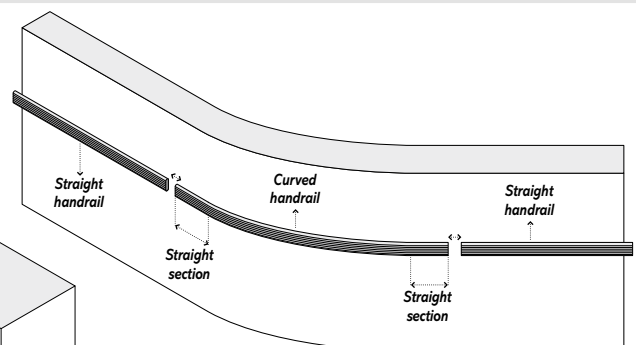
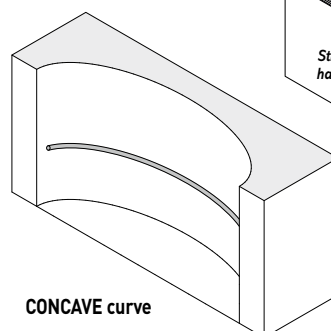
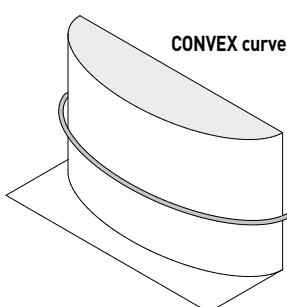



▶ JOINTING ACCESSORY

Applications

Aluminium joining piece with bactericidal joint to bring perfectly into line and to hold tight between two straight lengths of Escort or Linea'Touch handrails.

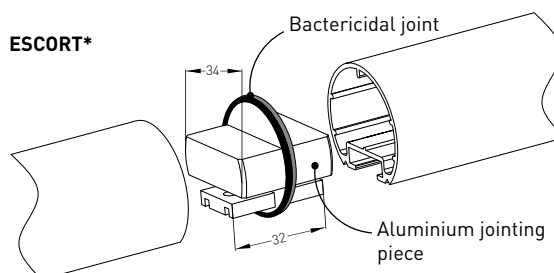

* also available for the handrail Linea'Touch

▶ RAPID'ANGLE FOR STAIRCASES AND FOR 80° TO 180° ANGLES

Applications

Gerflor has developed **Rapid'Angle®** for Escort round handrail and for Linea'Touch trilobed handrail especially designed:

- to fit in all staircase layouts with slope link and angled slope link : rotating 3D
- to fit all angles: modular from 80° to 180°

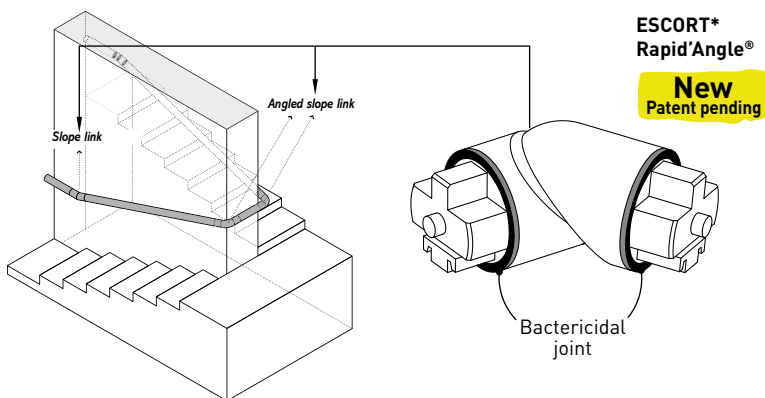

* also available for the handrail Linea'Touch

▶ DUAL-HEIGHT SPECIAL "ACCESSIBILITY" BRACKET: ESCORT

Applications

This dual-height bracket simplifies the installation of Escort handrails at two heights: one at the standard height and the other for children and/or those using wheelchairs. The height of the lower handrail has been specially designed to provide a comfortable aid to help such people to move around.

This accessory simplifies installation since only one set of horizontal marking outs is required for two levels of handrail.

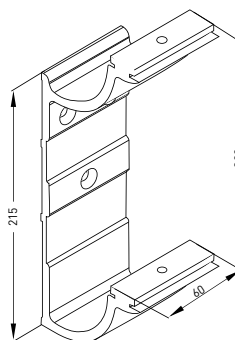

▶ TACTILE MARK: ESCORT

Applications

Unique design for this assembly wedge of tactile mark to be fitted in under the Escort handrail to provide locating help to visually impaired persons. Repeated, it helps indicate the where on the floor we are.

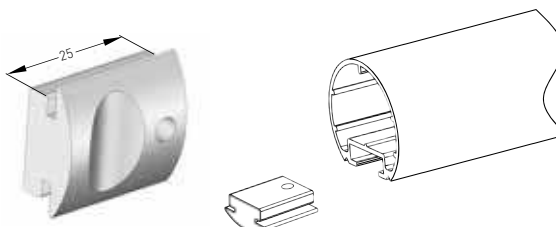

To help with the installation of SPM handrails, consult the installation procedures guide available upon request.

TOOLS

▶ LEISTER WALL WELDING CASE

Professional welding case includes all the tools required to create perfect welding rods between SPM panels or between SPM panels and PVC skirting.



Contains:

1. Leister electronic welding gun and a spare resistor
2. Narrow rapid nozzle diameter 4/5 mm
3. Straight-shaft quarter moon knife
4. Trimmer guide
5. Sharpening stone (dimensions 100 x 50 x 12 mm)
6. Nozzle brush (length 160 mm)
7. Aluminium utility ruler with handle (thickness: 4 mm - dimensions: 800 x 60 x 4 mm)
8. Mozart 2-in-1 trimming knife and 5 replacement blades
9. Triangular groover (length: 24 cm - 6 cm sides)
10. Trimming groover with rounded blade



▶ HOOKED BLADE CUTTER

This cutter's unique blade shape makes it ideal for cutting PVC panels and profiles.

Description

- Aluminium/plastic cutter
- Length 140 mm
- Includes tungsten carbide hooked blade and all-purpose blade

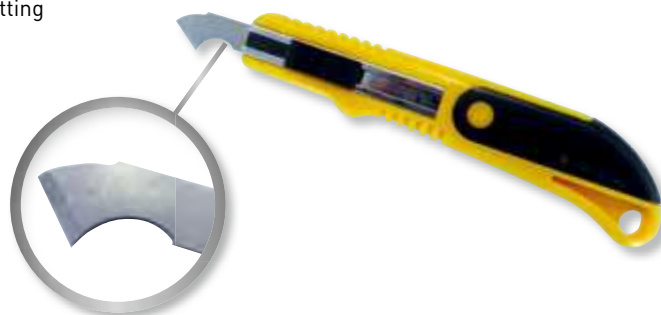

▶ TWO-HANDLED SMOOTHING ROLLER

Ideal for smoothing SPM panels after applying adhesive; offers substantial finishing pressure with its double handle and ease of use.

Description

- Roller length: 160 mm
- Roller diameter: 40 mm
- Dimensions (L x W x H):
210 mm x 180 mm x 120 mm



▶ THERMOFOLDING MACHINES

Specially designed and developed for folding SPM panels on-site.

Available in 2 sizes for making foldings over lengths of up to 1.30 m or 3.00 m.

Larger model equipped with rotary stop block.

Comes in case for easy transport and storage.

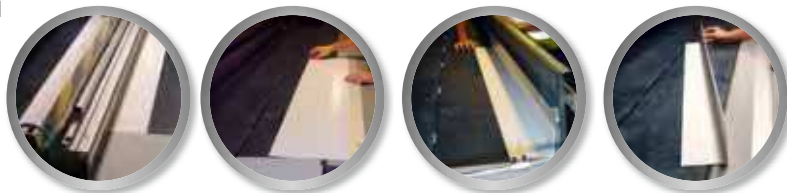

Description

Folding length in mm	1300	3000
Dimensions in mm (L x W x H)	1900 x 700 x 300	3600 x 700 x 300
Weight in kg	35	90
Voltage in V	220	220

COLOUR AVAILABILITY SUMMARY CHART



0001 Chalk	0031 Alum	0032 Flint	0033 Slate	0011 Pebble	0002 Gravel	0003 Clay	0004 Granite	0014 Cinnamon	0009 Sienna	0010 Bark	0005 Schist	0006 Ivory	0007 Wicker	0008 Sand	0013 Greige	0021 Straw	0022 Apricot	0027 Melon	0028 Poppy	0034 Magnolia	0015 Lavender grey
------------	-----------	------------	------------	-------------	-------------	-----------	--------------	---------------	-------------	-----------	-------------	------------	-------------	-----------	-------------	------------	--------------	------------	------------	---------------	--------------------

WALL PROTECTION																					
LINEA'PUNCH	p.32	*	*	*	*	*	*	*	*	*	*	*	*	*	*	*	*	*	*	*	*
IMPACT 200	p.34	*	*	*	*	*	*	*	*	*	*	*	*	*	*	*	*	*	*	*	*
IMPACT 120	p.34	*	*	*	*	*	*	*	*	*	*	*	*	*	*	*	*	*	*	*	*
IMPACT 60	p.34	*				*			*			*	*								
CONTACT 350	p.36	*				*	*	*	*		*	*	*			*	*	*			
CONTACT 200	p.36	*	*	*	*	*	*	*	*	*	*	*	*	*	*	*	*	*	*	*	*
DECOCHOC	p.38	*	*	*	*	*	*	*	*	*	*	*	*	*	*	*	*	*	*	*	*
DECOSMIC	p.39																				
DECOWOOD	p.40																				
DECOTREND	p.41																				
DECOCLEAN	p.42	*				*			*			*	*								
DECOCHOC H20	p.43																				
FIN'COLOR	p.45	*	*	*	*	*	*	*	*	*	*	*	*	*	*	*	*	*	*	*	*
DECOFRESC <i>all public contemporary</i>	p.46	*	*	*	*	*	*	*	*	*	*	*	*	*	*	*	*	*	*	*	*
BEDKIT	p.52	*	*	*	*	*	*	*	*	*	*	*	*	*	*	*	*	*	*	*	*
CORNER PROTECTORS																					
CAPCORN	p.56	*				*			*			*	*								
CORNEA	p.57	*	*	*	*	*	*	*	*	*	*	*	*	*	*	*	*	*	*	*	*
CORNEAFLEX	p.58	*				*			*			*	*								
LINEA'FLEX	p.60	*	*	*	*	*	*	*	*	*	*	*	*	*	*	*	*	*	*	*	*
PROTECTA 2	p.62	*	*	*	*	*	*	*	*	*	*	*	*	*	*	*	*	*	*	*	*
PROFILA 50	p.63	*	*	*	*	*	*	*	*	*	*	*	*	*	*	*	*	*	*	*	*
PROFILA 30	p.63	*	*	*	*	*	*	*	*	*	*	*	*	*	*	*	*	*	*	*	*
DOOR PROTECTION																					
FOOT-HEIGHT DOOR Contact 200 plate	p.66	*	*	*	*	*	*	*	*	*	*	*	*	*	*	*	*	*	*	*	*
FOOT-HEIGHT DOOR Contact 350 plate	p.66	*				*	*	*	*		*	*	*			*	*	*			
HALF-HEIGHT STRAIGHT Decochoc / Decosmic panels	p.67	*	*	*	*	*	*	*	*	*	*	*	*	*	*	*	*	*	*	*	*
HALF-HEIGHT DECORATIVE Decochoc / Decosmic panels	p.68	*	*	*	*	*	*	*	*	*	*	*	*	*	*	*	*	*	*	*	*
HANDPLATES Decochoc / Decosmic panels	p.70	*	*	*	*	*	*	*	*	*	*	*	*	*	*	*	*	*	*	*	*
INLAID SIGNAGE Decochoc / Decosmic panels	p.71	*	*	*	*	*	*	*	*	*	*	*	*	*	*	*	*	*	*	*	*
EDGES AND FRAMES Decochoc / Decosmic panels	p.72	*	*	*	*	*	*	*	*	*	*	*	*	*	*	*	*	*	*	*	*
THERMOFORMING Decochoc / Decosmic panels	p.73	*	*	*	*	*	*	*	*	*	*	*	*	*	*	*	*	*	*	*	*

COLOUR AVAILABILITY SUMMARY CHART

0001 Chalk	0031 Alum	0032 Flint	0033 Slate	0011 Pebble	0002 Gravel	0003 Clay	0004 Granite	0014 Cinnamon	0009 Sienna	0010 Bark	0005 Schist	0006 Ivory	0007 Wicker	0008 Sand	0013 Greige	0021 Straw	0022 Apricot

HANDRAILS		0001 Chalk	0031 Alum	0032 Flint	0033 Slate	0011 Pebble	0002 Gravel	0003 Clay	0004 Granite	0014 Cinnamon	0009 Sienna	0010 Bark	0005 Schist	0006 Ivory	0007 Wicker	0008 Sand	0013 Greige	0021 Straw	0022 Apricot
PERFORMER 2	p. 76	*				*	*	*	*		*		*	*	*			*	*
STARLINE - PVC SHEATHED	p. 78	*					*												
STARLINE - ANODISED	p. 78																		
BAND FOR STARLINE : - PVC SHEATHED OR ANODISED	p. 79	*	*	*	*	*	*	*	*	*	*	*	*	*	*	*	*	*	*
- DECOWOOD / DECOTREND	p. 81																		
LINEA TOUCH AND LINEA TOUCH+ PVC SHEATHED	p. 82	*	*	*	*	*	*	*	*	*	*	*	*	*	*	*	*	*	*
LINEA TOUCH - DECOWOOD	p. 84																		
LINEA TOUCH - ANODISED	p. 84																		
ESCORT - PVC SHEATHED	p. 86	*	*	*	*	*	*	*	*	*	*	*	*	*	*	*	*	*	*
ESCORT - DECOWOOD	p. 88																		
ESCORT - ANODISED	p. 88																		

0092 Fawn	0093 Swan	0091 Dolphin	0090 Canary

INDIVIDUAL PROTECTION		0092 Fawn	0093 Swan	0091 Dolphin	0090 Canary
SAFYCORNER	p. 90	*	*	*	*
SAFYDOOR	p. 91	*	*	*	*

* On stock (subject to stock availability)

0027 Melon	0028 Poppy	0034 Magnolia	0015 Lavender grey	0030 Iris	0029 Garnet	0016 Glacier	0018 Azure	0017 Bluebell	0020 Denim	0024 Bamboo	0023 Meadow	0025 Emerald	0019 Ultramarine	0060 Maple	0061 Beech	0062 Light oak	0067 Wenge	0065 Stripped pine	0069 Brown cedar	0068 Smoky cedar	0050 Brushed aluminium	0051 Composite	0052 Light concrete	0053 Medium concrete	0080 Silver	0081 Copper	0082 Gold
*								*	*	*																	
*	*	*	*	*	*	*	*	*	*	*	*	*	*														
*	*		*	*	*	*	*	*	*	*	*	*	*	*	*	*	*	*	*	*	*	*	*	*	*	*	*
														*	*	*	*	*									
*	*		*	*	*	*	*	*	*	*	*	*	*														
														*	*	*	*	*									

* On stock (subject to stock availability) On order with a minimum order quantity⁽¹⁾

(1) Minimum quantity: 200 ml within 4 to 8 weeks - depending on products and colours

▶ INSTALLATION CONDITIONS

If the products are to be installed in temperature conditions very different to 20°C (such as unheated premises in winter), take into account dimensional variations indicated in the below table.

Temperature in °C	Dimensional variations in mm for 1 linear meter	Comments
15	-1	Minimum temperature
20 (ideal temperature)	0	Ideal temperature
25	+1	Admissible temperature
30	+2	Maximum temperature

For detailed instructions, please refer to installation procedures brochure.

DOCUMENTS AND SAMPLE CARDS AVAILABLE

SPM brochure



You will find in this catalogue, all relevant technical information on our products: cut to scale 1, description, application, colour palette....

Installation procedures

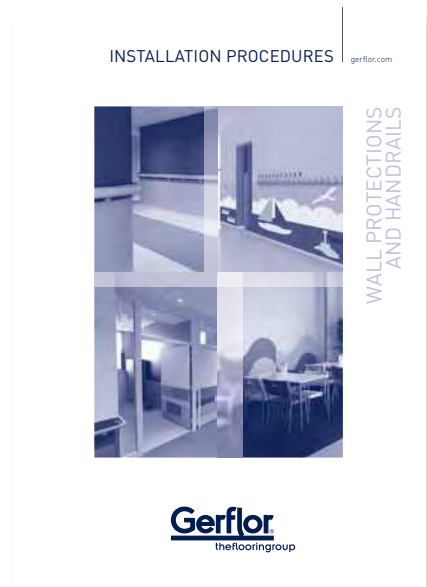

A guide which precisely details installation conditions and steps to follow.



Sample card

This tool has been created to help you choose colours in your projects. All colours from the SPM range are presented with movable samples.

Public building solutions

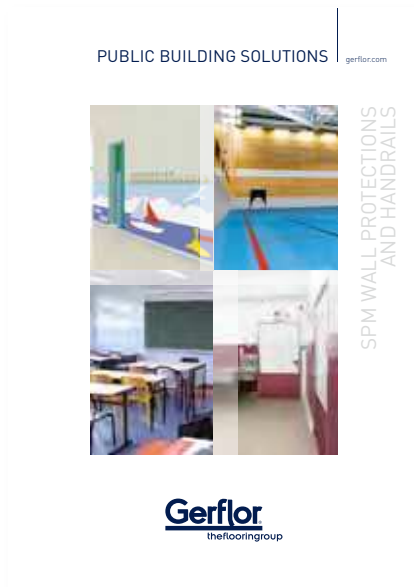

In child care centres, schools, gymnasiums, collective catering and leisure facilities, central kitchens, etc... intensive or repetitive traffic can cause significant premature wear. As these living and work spaces need to be comfortable and fit for purpose, Gerflor provides solutions to protect and decorate walls and doors.

Healthcare solutions



One solution for one need! The concerns to protect an operating theatre, an emergency department corridor or a bedroom are quite different. Here is the opportunity to get the benefit of our over 35 years experience in the health sector and to discover our solutions dedicated to hospitals, clinics, retirement homes...

51 colours and decors SPM palette



Colours are not contractually binding.

INDEX

B

- Bedkit p. 52
- Bending p. 72

C

- Capcorn p. 56
- Case - Wall welding p. 96
- Colours p. 22 to 29 & 98 to 101
- Contact 350, 200 p. 36 & 66
- Contents p. 03
- Cornea p. 57
- Corneaflex p. 58
- Curving p. 96
- Cutter - Hooked blade p. 96

D

- Decocare p. 50
- Decochoc p. 38
- Decochoc H2O p. 43
- Decoclean p. 42
- Decofresc p. 46
- Decokid p. 51
- Decoprint p. 48
- Decosmic p. 39
- Decotrend p. 41
- Decowood p. 40
- Documents p. 102

E

- Early childhood p. 47
- Escort anodised p. 88
- Escort Decowood p. 88
- Escort PVC sheathed p. 86
- Environment p. 06

F

- Fin'Alu p. 44
- Fin'Color p. 45
- Fixing and finishing p. 93

H

- Hygiene p. 05

I

- Impact 200, 120, 60 p. 34
- Innovation p. 07

L

- Linea'Punch p. 32
- Linea'Flex p. 60
- Linea'Touch anodised p. 84
- Linea'Touch Decowood p. 84
- Linea'Touch PVC sheathed p. 82

M

- Masks for doors p. 68 to 70

N

- Numbers p. 71

P

- Palette of colours p. 22
- Performer 2 p. 76
- Pictos p. 71
- Plac'Inox p. 53
- Profila 50 & 30 p. 63
- Protecta 2 p. 62
- Profil'Inox p. 59

R

- Rapid'Access p. 94
- Rapid'Angle p. 95
- Resistance p. 05
- Roller (smoothing) p. 97

S

- Safycorner p. 90
- Safydoor p. 91
- Service ducts p. 94
- Signage inlaid p. 71
- Smoothing Roller p. 97
- Solutions per sector p. 10 to 21
- Starline anodised p. 78
- Starline Decotrend p. 80
- Starline Decowood p. 80
- Starline PVC sheathed p. 78

T

- Thermoforming p. 73 & 93
- Thermofolding machine p. 97
- Thermo-welding p. 92
- Tools p. 96

ASIA: Gerflor Asia
Tel: +86 21 6357 8818 - Fax: +86 21 6357 8998
e-mail: gerflorasia@gerflor.com

AUSTRALIA/NEW ZEALAND: Gerflor Australasia Pty. Ltd
Australia Tel: 1 800 060 785 - New Zealand Tel: 0 800 630 119
e-mail: gerflor@gerflor.com.au

AUSTRIA/SWITZERLAND: Gerflor GmbH
Tel: +43 (0)72 29/70 800-0 - Fax: +43 (0)72 29/70 800-218
e-mail: austria@gerflor.com - switzerland@gerflor.com

BELGIUM/LUXEMBURG: Gerflor Benelux
Tel: +32 (0)3 766 42 82 - Fax: +32 (0)3 766 29 14
e-mail: gerflorbel@gerflor.com

CANADA: Gerflor International
Tel: +1 438 333 0752 - Fax: +1 438 380 5425
e-mail: gerflorcanada@gerflor.com

CHINA: Gerflor floorings (China) Co. Ltd.
Tel: +86 21 6357 8818 - Fax: +86 21 6357 8998
e-mail: gerflorchina@gerflor.com

FINLAND: Gerflor Oy
Tel: +358 (0) 10 6 17 5150 - Fax: +358 (0) 10 617 5152
e-mail: info@gerflor.fi

FRANCE: SPM
Customer department:
Tel: +33 (0)5 34 39 41 00 - Fax: +33 (0)5 34 39 41 02
e-mail: export@spm.fr

GERMANY: Gerflor Mipolam GmbH
Tel: +49 (0)22 41-25 30-0
e-mail: gerflormipolam@gerflor.com
Kunden-Service
Tel: +49 (0) 22 41-25 30-136 - Fax: +49 (0) 22 41-25 30-100
e-mail: kundenservice@gerflor.com
SAT Service und Anwendungstechnik
tel: +49 (0)22 41-25 30 555 - Fax: +49 (0)22 41-25 30 550
e-mail: technik@gerflor.com

IRELAND: Gerflor Ltd
Tel: +353 (0) 42 966 1431 - Fax: +353 (0) 42 966 1759
e-mail: gerflorirl@gerflor.com

ITALY: Gerflor S.p.A.
Tel: +39 02 90 40 10 - Fax: +39 02 90 42 74 84
e-mail: gerfloritalia@gerflor.com

LATIN AMERICA (Brazil): Gerflor América Latina
Tel: +55 11 38 48 20 20
e-mail: gerflor@gerflor.com.br

MIDDLE EAST: Gerflor Middle East
Tel: +966 13 847 1779 - Fax: +966 13 847 1781
e-mail: info@gerflorme.com

NETHERLANDS: Gerflor Benelux
Tel: +31 (0)40 266 17 00 - Fax: +31 (0)40 257 46 89
e-mail: gerflornl@gerflor.com

OTHER COUNTRIES: Gerflor International
Tel: +33 (0)4 74 05 40 00 - Fax: +33 (0)4 74 05 03 13
e-mail: gerflorcontract@gerflor.com

POLAND: Gerflor Polska Sp z o.o
Tel: +48 61 823 34 01 - Fax: +48 61 823 34 33
e-mail: info@gerflor.pl

PORTUGAL: Gerflor Iberia, SA
Tel: +351 21 843 95 49 - Fax: +351 21 846 55 44
e-mail: gerflorportugal@gerflor.com

RUSSIA: Gerflor zao
Tel./Fax: +7 495 785 23 71
e-mail: gerflorussia@gerflor.ru

SCANDINAVIA: Gerflor Scandinavia a.s.
Tel: +47 64 95 60 70 - Fax: +47 64 95 60 80
e-mail: gerflorscand@gerflor.no

SPAIN: Gerflor Iberia, SA
Tel: +34 91 653 50 11 - Fax: +34 91 653 25 85
e-mail: gerfloriberia@gerflor.com

UNITED KINGDOM: Gerflor Ltd
Sample service: Contractuk@gerflor.com
Office Tel: +44 (0) 1926 622 600 - Fax: +44 (0) 1926 401 647

USA: Gerflor North America
Tel: 877 GERFLOR (437 3567) - Fax: 847 394 3753
e-mail: info@gerflorusa.com



Health
& Safety



ISO 14001



Recycling



Life Cycle
Analysis

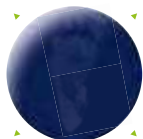

Committed to sustainable development

gerflor.com

ARCHITECTURE
DECORATION
SPORT
TECHNOSPECIFIC

Gerflor. Don't forget our complementary ranges!



Flooring



Entrance mats



Skirtings & Profiles

and Be CONNECTED!



www.gerflor.com

Gerflor
theflooringgroup