

MONDOTRACK / WS



CONFIDENTIAL. FOR INTERNAL USE ONLY. Any reproduction, whether partial or total, including transmission of the information contained in the present document, must be approved in advance by MONDO.

 **MONDO**
TRACK & FIELD



CONFIDENTIAL. FOR INTERNAL USE ONLY. Any reproduction, whether partial or total, including transmission of the information contained in the present document, must be approved in advance by MONDO.

MONDOTRACK/WS

Specifically designed
for superior athletic performance,
MONDOTRACK/WS
provides the optimum blend of energy return
and comfort for both
high-speed sprint events and low-speed
Middle and long-distance events.



CONFIDENTIAL. FOR INTERNAL USE ONLY. Any reproduction, whether partial or total, including transmission of the information contained in the present document, must be approved in advance by MONDO.

MONDO
TRACK & FIELD

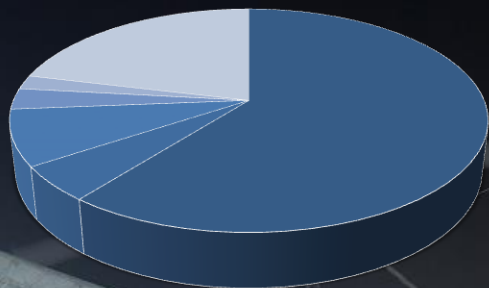

- MONDO
- BSW
- CONICA
- POLYTAN
- REKORTAN
- OTHERS

**63% OF THE WORLD RECORDS
PRESENTLY* RATIFIED BY THE IAAF
WERE SET ON A MONDO TRACK**

Last updated on 2nd September 2016

MEN'S 800M - FINAL	
1	ETH IRE DEBAYEMET
2	ETH IRE WASSANJOSL
3	USA IRE CHELIMO
4	IND IRE SINGH
5	OMR IRE WADAN
6	OMR IRE WUTCHART
7	USA IRE CHAFFIN
8	ETH IRE TADOS

CONFIDENTIAL. FOR INTERNAL USE ONLY. Any reproduction, whether partial or total, including transmission of the information contained in the present document, must be approved in advance by MONDO.



NEW 3D OMNI-DIRECTIONAL TESSELLATION™

Guarantees **20% extra surface drainage**, which provide an even greater grip in raining, conditions.

MONDOTRACK/WS



Joao Havelange Stadium,
Rio de Janeiro, Brazil

CONFIDENTIAL. FOR INTERNAL USE ONLY. Any reproduction, whether partial or total, including transmission of the information contained in the present document, must be approved in advance by MONDO.

MONDO
TRACK & FIELD

NEW 2-PHASE VULCANIZATION™

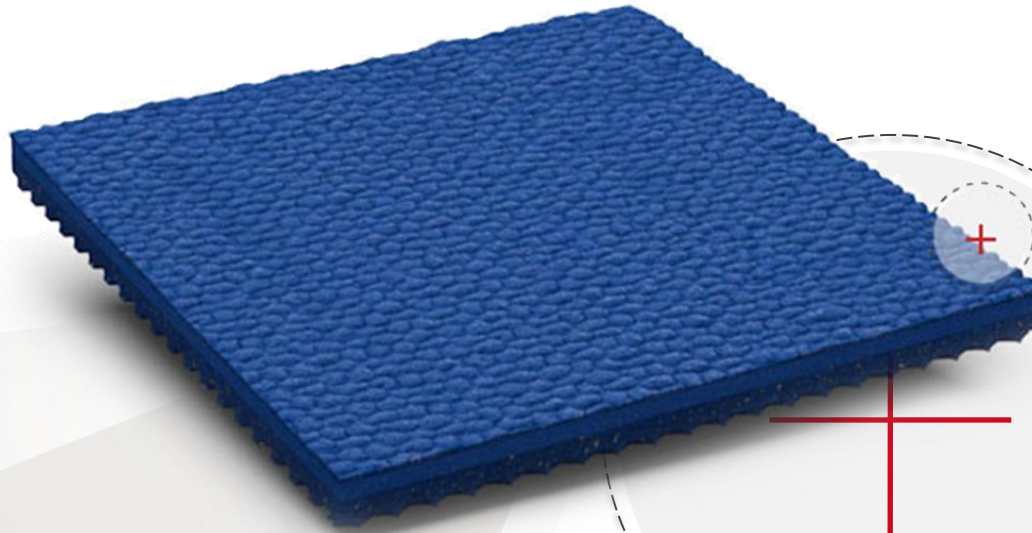

The top layer hosts a three-dimensional network of deformable elements, with controlled composition and elasticity, that guarantee a significant increase in the elastic response of the surface and ensure uniformity of dynamic response over the whole track.

Bottom Layer

MONDOTRACK/WS

Elongated Honeycomb Backing

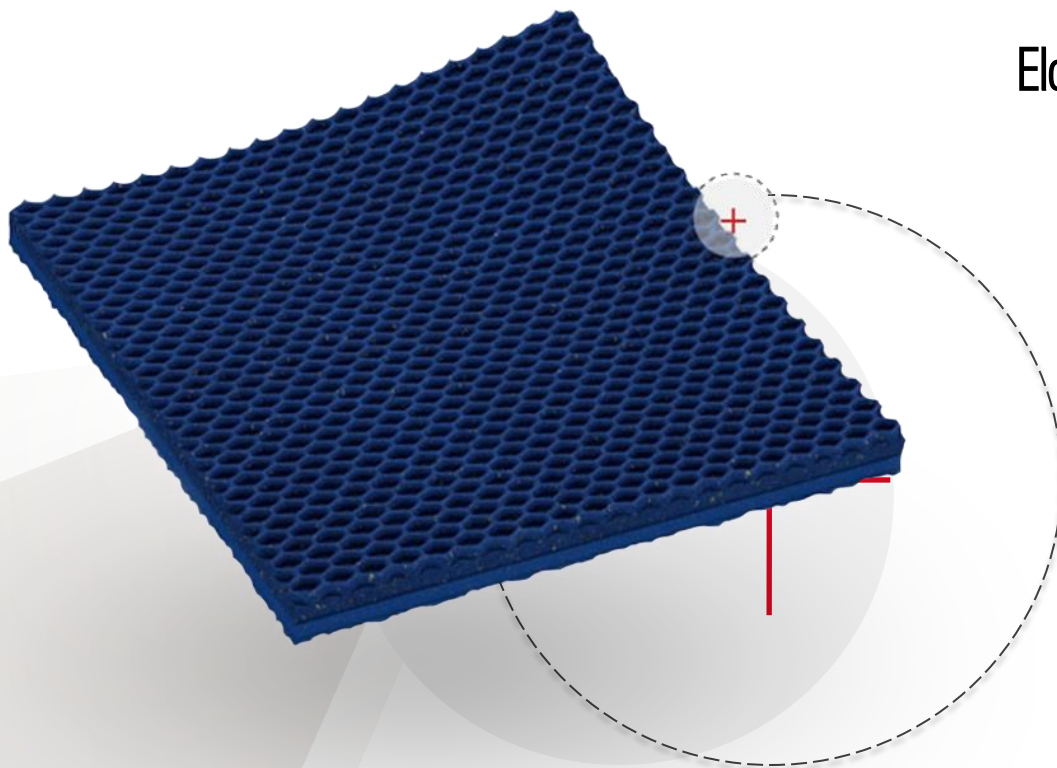

Hexagonal air-filled chambers surrounded by ribs that deform in three dimensions on the track underlayment minimize the time the athlete is in contact with the flooring, maximize energy return, and optimize the floor's reaction time.

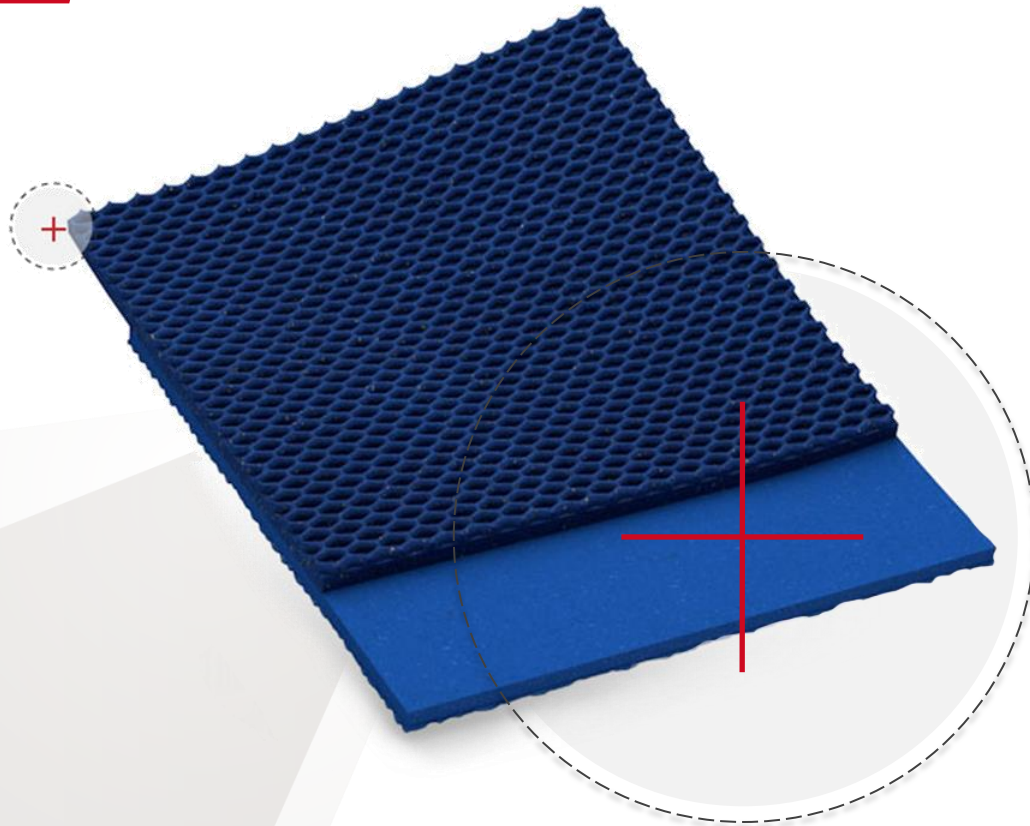

SEAMLESS CONSTRUCTION

The vulcanization process guarantees molecular bond between the top and bottom layers. The end result is a continuous, seamless piece of material

Track/foot interaction

MONDOTRACK/WS

FOOT IMPACT/FORCE REDUCTION

FOOT IMPACT/FORCE REDUCTION

As the athlete's foot impacts the surface, the air cells compress, absorbing impact forces and vibrations, and converting the maximum amount of kinetic energy into stored energy.

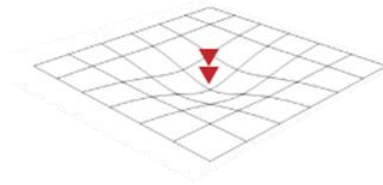

CONFIDENTIAL. FOR INTERNAL USE ONLY. Any reproduction, whether partial or total, including transmission of the information contained in the present document, must be approved in advance by MONDO.

MONDO
TRACK & FIELD

Track/foot interaction

MONDOTRACK/WS

ROLLING OF THE FOOT/LATERAL SUPPORT



ROLLING OF THE FOOT/LATERAL SUPPORT

The lateral deformation of the rhomboid-shaped cells helps reduce the time interval required to complete the rolling of the foot while providing continuous optimal support to the foot movement.

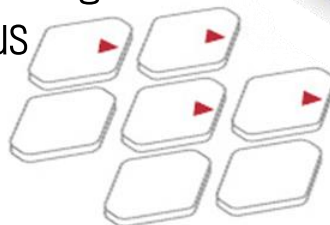

CONFIDENTIAL. FOR INTERNAL USE ONLY. Any reproduction, whether partial or total, including transmission of the information contained in the present document, must be approved in advance by MONDO.

MONDO
TRACK & FIELD

Track/foot interaction

MONDOTRACK/WS



LOADING PHASE/TRACTION

LOADING PHASE/TRACTION

Traction is enhanced to the point where spikes are not required to penetrate the surface. Compression spikes will cause maximum deflection, and boost accumulation of stored energy.

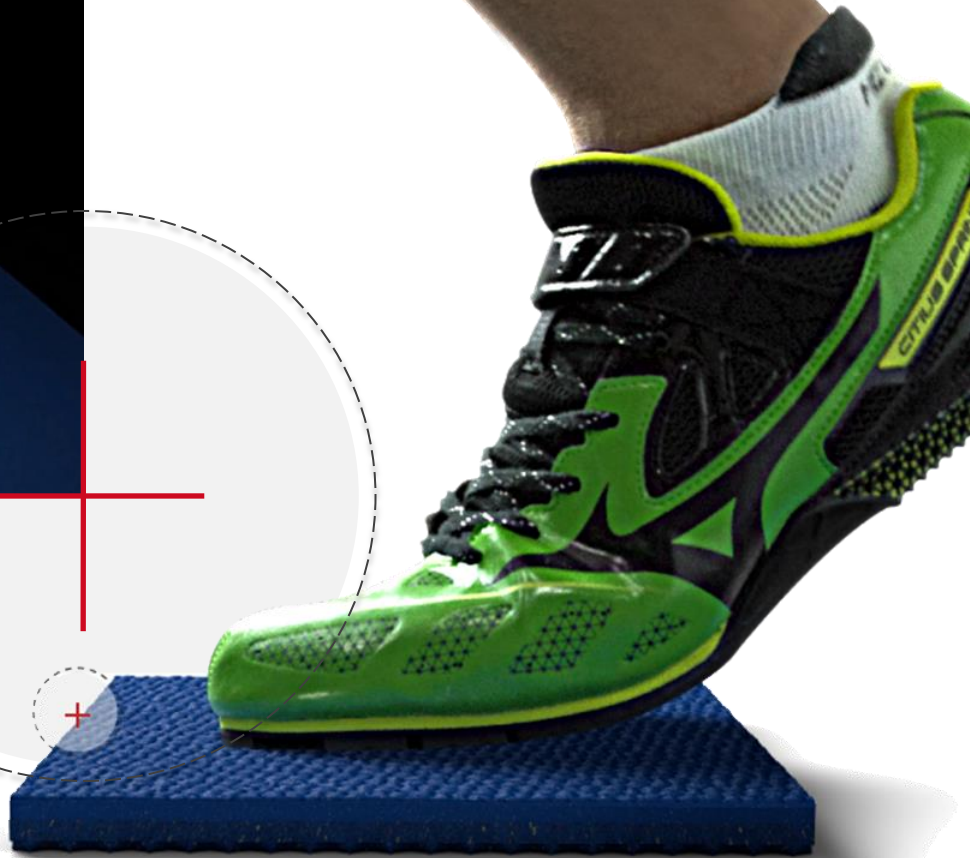
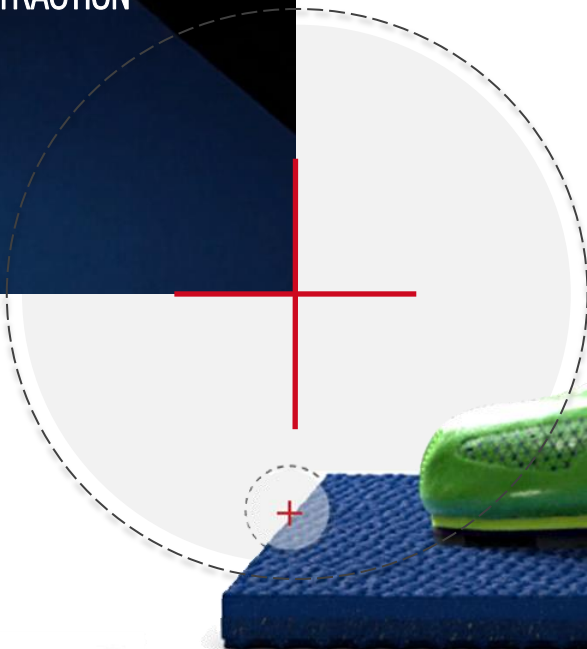
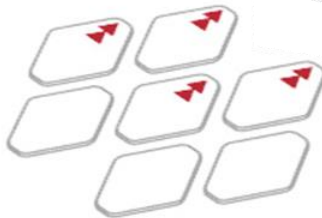

CONFIDENTIAL. FOR INTERNAL USE ONLY. Any reproduction, whether partial or total, including transmission of the information contained in the present document, must be approved in advance by MONDO.

Track/foot interaction

MONDOTRACK/WS

PROPULSION PHASE/BOWSTRING EFFECT



PROPULSION PHASE/BOWSTRING EFFECT

When the foot leaves the surface, the track recovers acting like a bowstring, releasing the greatest portion of stored energy and literally launching the athlete forward, away from the surface.

CONFIDENTIAL. FOR INTERNAL USE ONLY. Any reproduction, whether partial or total, including transmission of the information contained in the present document, must be approved in advance by MONDO.



Postural alignment, leg stiffness adjustment and pelvic motion are minimized to reduce energy and increase efficiency.

Uniformity of dynamic response gives athletes complete control over Stride length, running and rhythm and balance.

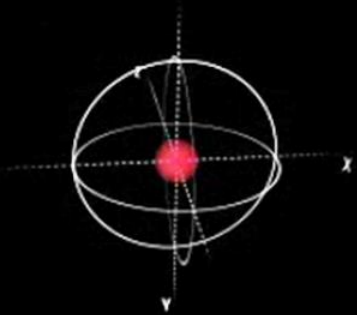

THE TRACK OF RECORDS

3 WR were set within 4 weeks of the product launch date in occasion of the 2016 Muller Anniversary Games in London

Queen Elizabeth Olympic Stadium
London

CONFIDENTIAL. FOR INTERNAL USE ONLY. Any reproduction, whether partial or total, including transmission of the information contained in the present document, must be approved in advance by MONDO.

MONDO
TRACKS/FIELD

Queen Elizabeth Olympic Stadium
London

Ω OMEGA Ω OMEGA

MONDO TRACK/WS



Muller Anniversary Games, Queen Elizabeth Olympic Stadium, London, Great Britain

22/07/2016 100 mt Hurdles WR (W) by Kendra Harrison 12.20

The previous record holder Yordanka Donkova (12.21) has held the record since 1988.

CONFIDENTIAL. FOR INTERNAL USE ONLY. Any reproduction, whether partial or total, including transmission of the information contained in the present document, must be approved in advance by MONDO.

MONDO
TRACK & FIELD

Rio 2016 Olympic Games, Joao Havelange Stadium, Rio, Brazil

12/08/2016 10.000 mt WR (W) by Almaz Ayana 29:17.45

The previous record holder Giuxia Wang (29:31.78) has held the record since 1993.

14/08/2016 400 mt WR (M) by Wayde Van Niekerk 43.03

The previous record holder Michael Johnson (43.18) has held the record since 1999.



Joao Havelange, Stadium,
Rio de Janeiro, Brazil



Joao Havelange, Stadium,
Rio de Janeiro, Brazil

MONDOTRACK/WS

MONDOTRACK WS THE OLYMPIC TRACK OF RIO2016 OLYMPIC GAMES



CONFIDENTIAL. FOR INTERNAL USE ONLY. Any reproduction, whether partial or total, including transmission of the information contained in the present document, must be approved in advance by MONDO.

MONDO
TRACK & FIELD

MONDOTRACK/WS



Joao Havelange Stadium,
Rio de Janeiro, Brazil

CONFIDENTIAL. FOR INTERNAL USE ONLY. Any reproduction, whether partial or total, including transmission of the information contained in the present document, must be approved in advance by MONDO.

MONDO
TRACK & FIELD

MONDOTRACK/WS

Joao Havelange Stadium,
Rio de Janeiro, Brazil

4x400

CONFIDENTIAL. FOR INTERNAL USE ONLY. Any reproduction, whether partial or total, including transmission of the information contained in the present document, must be approved in advance by MONDO.

MONDO
TRACK & FIELD

MONDOTRACK/WS

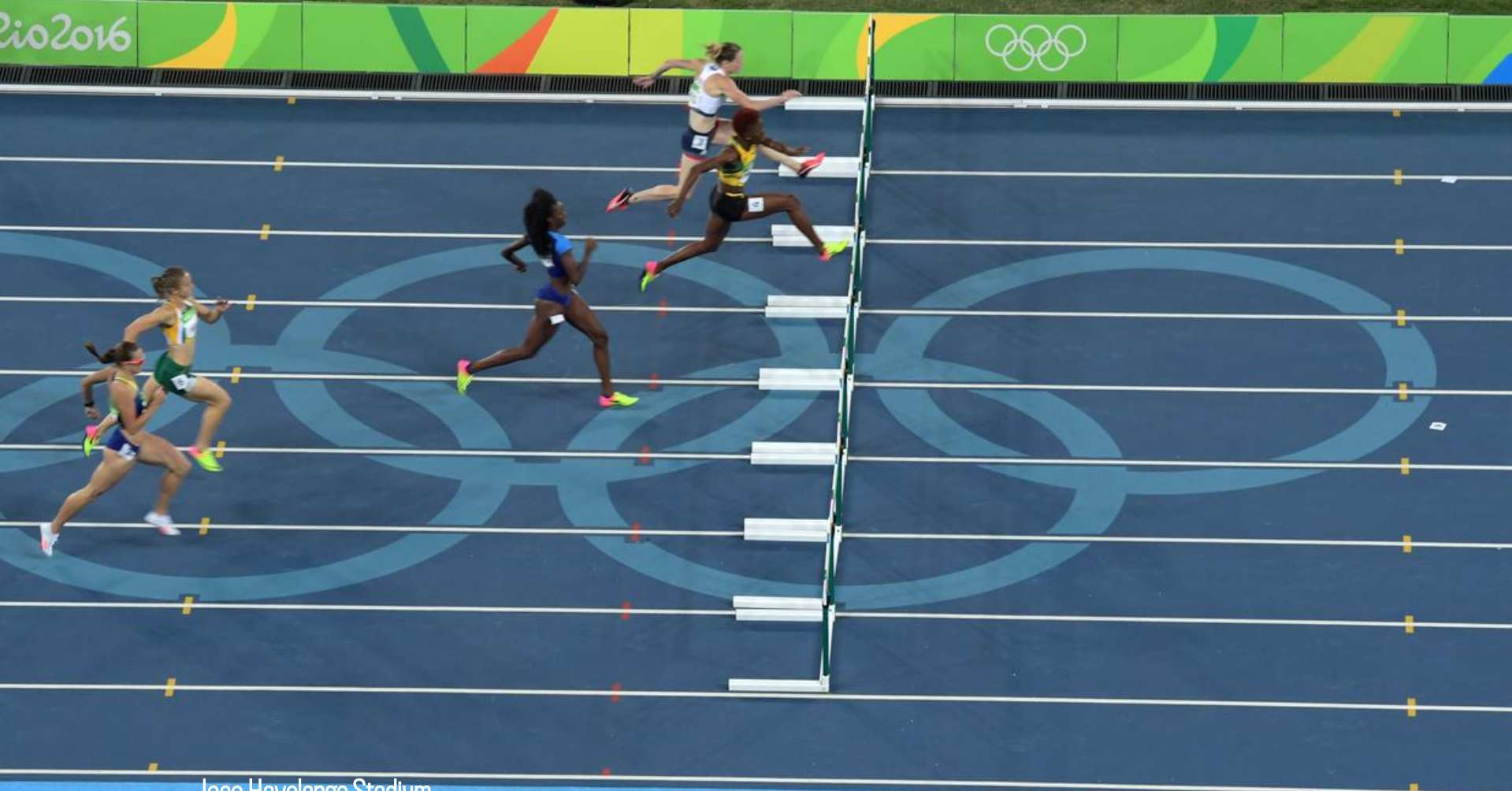

Joao Havelange Stadium,
Rio de Janeiro, Brazil

CONFIDENTIAL. FOR INTERNAL USE ONLY. Any reproduction, whether partial or total, including transmission of the information contained in the present document, must be approved in advance by MONDO.

MONDO
TRACK & FIELD

MONDOTRACK/WS

IAAF World Athletics Championship London 2017: athletes competed on MONDOTRACK/WS

Queen Elizabeth Olympic Stadium,
London UK

CONFIDENTIAL. FOR INTERNAL USE ONLY. Any reproduction, whether partial or total, including transmission of the information contained in the present document, must be approved in advance by MONDO.

MONDO
TRACK&FIELD



MONDO TRACK/WS

Queen Elizabeth Olympic Stadium,
London UK

CONFIDENTIAL. FOR INTERNAL USE ONLY. Any reproduction, whether partial or total, including transmission of the information contained in the present document, must be approved in advance by MONDO.

MONDO
TRACK & FIELD

MONDOTRACK/WS

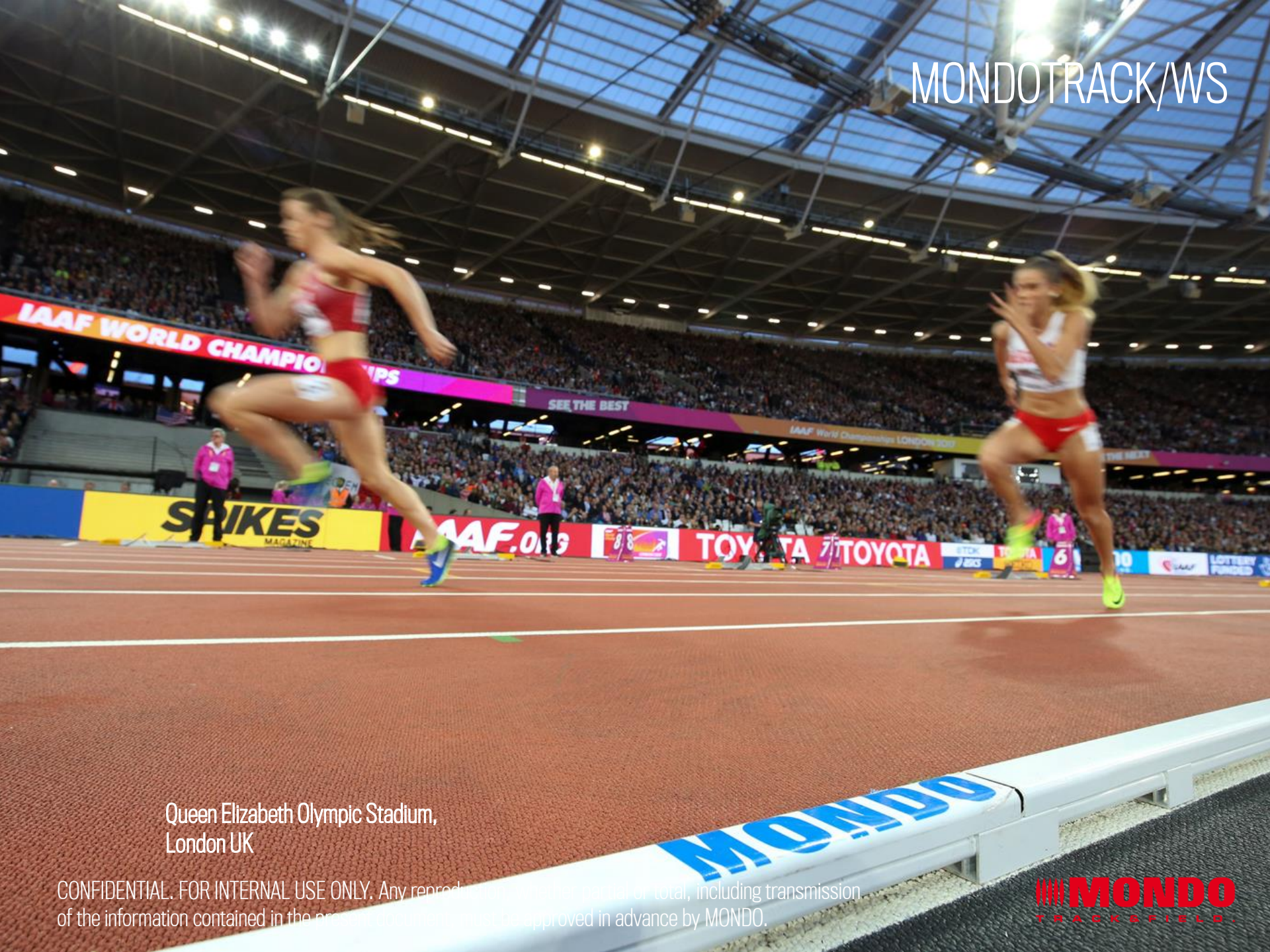

Queen Elizabeth Olympic Stadium,
London UK

CONFIDENTIAL. FOR INTERNAL USE ONLY. Any reproduction, in whole or in part, including transmission of the information contained in the present document, must be approved in advance by MONDO.

MONDO
TRACKFIELD

MONDOTRACK/WS



Queen Elizabeth Olympic Stadium,
London UK

CONFIDENTIAL. FOR INTERNAL USE ONLY. Any reproduction, whether partial or total, including transmission of the information contained in the present document, must be approved in advance by MONDO.

MONDO
TRACK&FIELD

MONDOTRACK/WS

MONDOTRACK/WS: the surface of choice of the IAAF World Athletics Championship in DOHA2019

Al Khalifa Stadium,
Doha Qatar

CONFIDENTIAL. FOR INTERNAL USE ONLY. Any reproduction, whether partial or total, including transmission of the information contained in the present document, must be approved in advance by MONDO.

MONDO
TRACK & FIELD

Shock Absorption & Vertical Deformation

FORCE REDUCTION % vs. TEMPERATURE °C

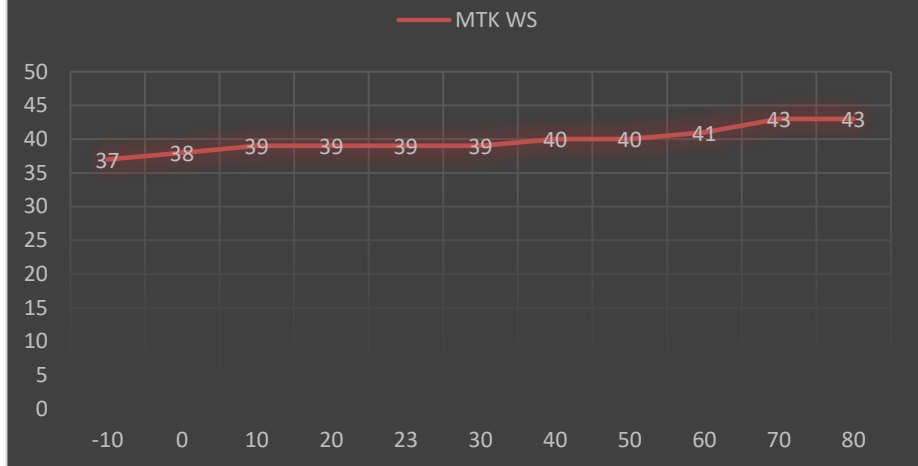

VERTICAL DEFORMATION mm vs. TEMPERATURE °C

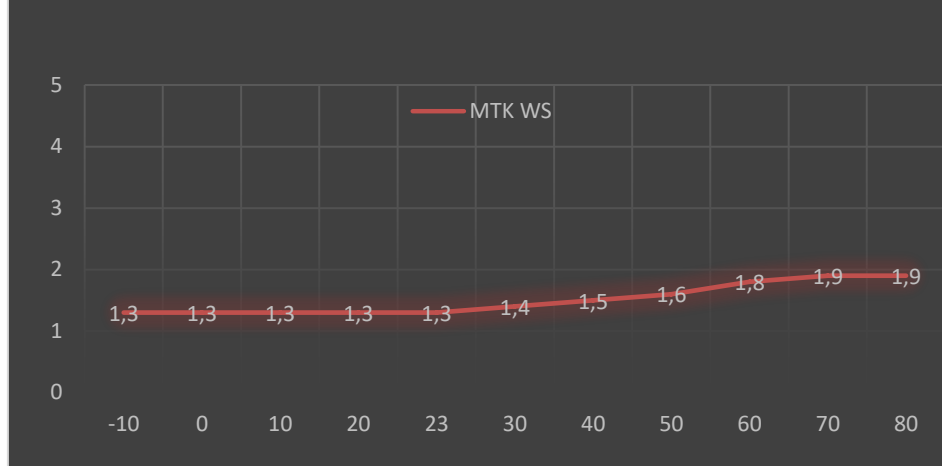

IAAF Requirements 35 – 50%

IAAF Requirements 0.6 – 2.5 mm

Mondotrack /WS has been tested at expanded temperature intervals to determine the performance of the surface at -10°, 60°, 70°, 80° C in addition to the normal IAAF temperature requirements (0° - 50° C).

Results meet IAAF requirements at expanded temperature.

The track has a constant behavior at all temperatures, which allows use of the track in extreme conditions and within the same race ensures a certain constancy of athletic performance (eg. in areas in sun or shade).



Breathe Healthy Indoor Version



Mondotrack WS is certified **GREENGUARD GOLD** low-emission of VOCs in schools and healthcare facilities

Mondotrack WS is available in a special version that is **specifically formulated for indoor applications**, with emission of Volatile Organic Compounds (VOCs) in compliance with the **most stringent indoor air quality standards**, providing an **effective contribution against air pollution**, which has an impact on **athlete's health, well-being and performance**

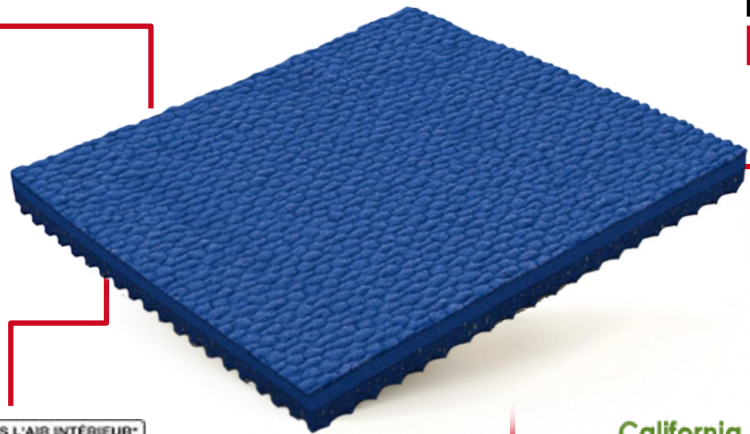

Mondotrack WS is fire-rated **Cfl-s1** in accordance with the Euroclass system, which dictates the best safeguards in the case of fire, including minimal toxicity



Mondotrack WS is rated **A+** according to the **FRENCH REGULATION** for low-emission Construction Products



Mondotrack WS complies with the requirements of the State of California's Department of Public Health for the emission of VOCs from Indoor Sources **CALIFORNIA SECTION 01350**



Sustainable Standard Version



Mondotrack WS is classified as non-hazardous waste with **EWC Code 170203**

As part of Mondo's commitment to **sustainability**, Mondotrack WS is specifically engineered to **minimize environmental impact** through all stages of the product's life, including production, use, and disposal.



Mondotrack WS satisfies the limitations imposed by the German **DIN 18035-6** Standard on the content of Heavy Metals and Dissolved Organic Carbon (DOC)



Mondotrack WS includes up to 42% of **post-consumer and post-industrial recycled materials**, and 6% of **rapidly renewable materials**



Mondotrack WS complies with the European Standard **REACH** that addresses the production and use of chemical substances based on their potential impacts on health and the environment

Characteristics

MONDOTRACK/WS



Mondotrack WS complies with the **European Standard EN 14877:2013** for athletics.



Mondotrack WS is certified by the International Association of Athletics Federations **IAAF**



MONDO OFFICIAL SUPPLIER TO 11 CONSECUTIVE EDITIONS OF THE OLYMPIC GAMES

MONDOTRACK/WS

Montreal 1976

Moscow 1980

Los Angeles 1984

Seoul 1988

Barcelona 1992

Atlanta 1996

Sydney 2000

Athens 2004

Beijing 2008

London 2012

Rio 2016

Joao Havelange Olympic Stadium,
Rio de Janeiro, Brazil

CONFIDENTIAL. FOR INTERNAL USE ONLY. Any reproduction, whether partial or total, including transmission of the information contained in the present document, must be approved in advance by MONDO.

MONDO
TRACK & FIELD